

## Monitor &amp; Control

**Monitor & Control**

This Help Guide describes how to operate Monitor & Control.

In addition to the Help Guide, information relating to configuration and operation of the app is available on the following support page. Use together with this Help Guide.

[Monitor & Control support page](#)

**Introduction****Applications**

- [Overview](#)

- [Switching the Screen](#)

---

[About This Help Guide](#)

---

[Connection Methods and Supported Functions](#)

---

[Lenses that Do Not Support Manual Focus Operation by Specifying a Distance](#)

**Connecting with ILME-FX3/ILME-FX30/ILCE-9M3**

---

[Connecting Using Bluetooth Pairing \(Simple Connection\)](#)

**Connecting via Wi-Fi**

- [Connecting Using Wi-Fi to a Camera Configured as an Access Point \(Wi-Fi Direct connection\) \(ILME-FX3/ILME-FX30/ILCE-9M3\)](#)

- [Connecting Using Wi-Fi to a Mobile Device Configured as an Access Point \(Tethering/Internet Sharing\) \(ILME-FX3/ILME-FX30/ILCE-9M3\)](#)

- [Connecting Using Wi-Fi via Wireless LAN Router Configured as an Access Point \(ILME-FX3/ILME-FX30/ILCE-9M3\)](#)

**Connecting via Wired LAN**

- [Connecting by Wired LAN via a Router \(ILCE-9M3\)](#)

---

[Authenticating Access When Connecting to a Camera \(ILME-FX3/ILME-FX30/ILCE-9M3\)](#)

**Connecting with ILME-FX6/MPC-2610****Connecting via Wi-Fi**

- [Setup When Connecting to MPC-2610 Using Wi-Fi](#)

- [Connecting Using Wi-Fi to a Camera Configured as an Access Point \(Wi-Fi Direct connection\) \(ILME-FX6/MPC-2610\)](#)

- [Connecting Using Wi-Fi to a Mobile Device Configured as an Access Point \(Tethering/Internet Sharing\) \(ILME-FX6/MPC-2610\)](#)

- [Connecting Using Wi-Fi via Wireless LAN Router Configured as an Access Point \(ILME-FX6/MPC-2610\)](#)

## Connecting via Wired LAN

- [Setup When Connecting to MPC-2610 Using Wired LAN](#)

- [Connecting by Wired LAN via a Router \(ILME-FX6/MPC-2610\)](#)

## Connecting via USB

- [Connecting Using USB to a Mobile Device Configured as an Access Point \(Tethering\) \(ILME-FX6/MPC-2610\)](#)

[Authenticating Access When Connecting to a Camera \(ILME-FX6/MPC-2610\)](#)

## Disconnecting from a Camera

[Disconnecting a Camera](#)

[Deleting Access Authentication Credentials from the App](#)

[Bluetooth Unpairing](#)

## Operating a Camera

[Shooting](#)

[Playing a Clip using the \[Monitoring\] Screen](#)

## Checking/Changing Camera Settings

- [Displaying and Changing Camera Settings using the App](#)

- [Basic Operation](#)

## Configuring Basic Camera Settings

- [White Balance](#)

- [Exposure](#)

- [Gain](#)

- [ISO](#)

- [Exposure Index](#)

- [Shutter Speed](#)

- [Image Stabilization](#)

- [Zoom](#)

- [ND Filter](#)

- [Iris](#)

## Adjusting the Focus

- [Focus](#)

[Iris/ND Filter](#)

---

[Assignable Buttons](#)

---

[Shooting Mode, Look, and Recording Format Settings](#)

---

[Importing a LUT](#)

---

[Other Settings](#)

---

## Displaying/Operating Clips

### Checking Clips

[Checking a Proxy Clip/Original Clip](#)

---

[Displaying a Clip Imported into a Mobile Device](#)

---

[Switching the Clip Display View](#)

---

### Operating Clips on the [Browse] Screen

[Renaming a Clip](#)

---

[Deleting a Clip](#)

---

[Importing a Proxy Clip using the \[Browse\] Screen](#)

---

[Transferring a Clip to an FTP Server using the \[Browse\] Screen](#)

---

[Sharing a Clip Imported into a Mobile Device](#)

---

### Operating Clips on the Player Screen

[Playing a Clip using the Player Screen](#)

---

[Importing a Proxy Clip using the Player Screen](#)

---

[Transferring a Clip to an FTP Server using the Player Screen](#)

---

[Transferring Part of a Clip to an FTP Server](#)

---

[Checking Clip Properties](#)

---

[Checking the Job List](#)

---

## Notice to Users

[Trademarks](#)

---

## Monitor &amp; Control

**Overview**

---

Monitor & Control (M&C) is an application that connects to a single camera and is used for remote control of the camera and to display/control clips from the camera. This app can be used free of charge.

TP1001125845

H-479-100-12(1) Copyright 2023 Sony Corporation

## Switching the Screen

This topic describes the structure of the app screen and how to switch between screens.

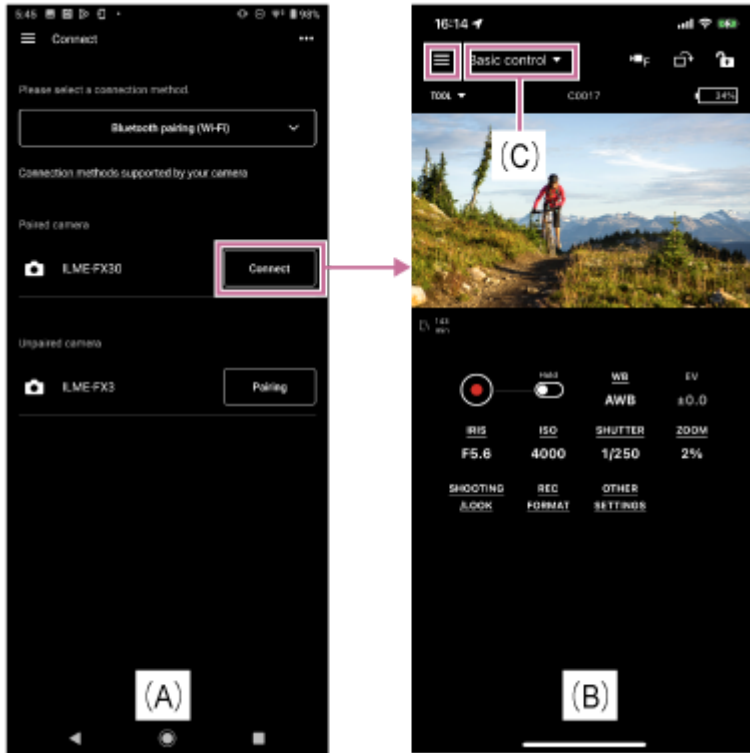

Tap [Connect] for a camera that you want to connect on the [Connect] screen (A) to display the [Monitoring] screen (B) for monitoring the camera image and controlling camera functions remotely.

### (App menu)

Selecting any of the following items from the menu on the [Monitoring] screen displays the screen for the corresponding item.

- [Connect]: Displays the camera connection screen (A).
- [Monitoring]: Displays the [Monitoring] screen (B).
- [Browse]: Displays the [Browse] screen for displaying and controlling playback of camera clips and for importing/transferring clips.

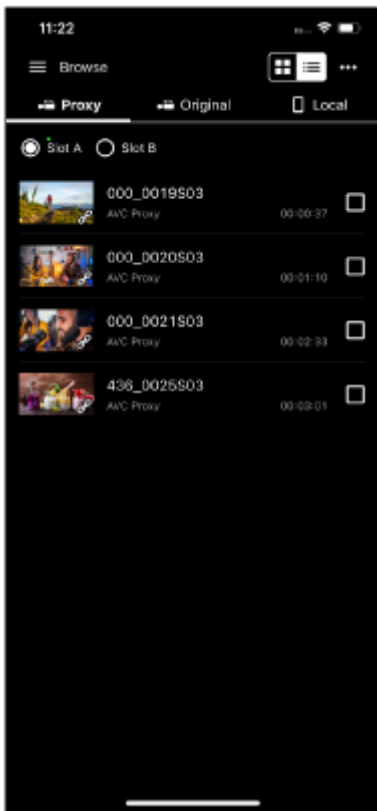

- [Job list]: Displays a screen for checking the import/transfer status of clips.
- [Settings/Support]: Displays the screen for configuring app settings.
- [Feedback]: Displays an external site for giving feedback about this app.

### Mode selection area (C)

Selecting any of the following modes in the  (App menu) mode selection area (C) displays the screen for the corresponding mode.

#### [Basic control] screen

This screen is used to configure the basic functions of the camera.



- Tap [SHOOTING/LOOK] to display the screen for configuring the shooting mode.



- Tap [REC FORMAT] to display the screen for configuring the recording format and related settings.



- Tap [OTHER SETTINGS] to display the screen for configuring other functions.

**Note**

- Not displayed if the camera is an ILME-FX6/MPC-2610.



**[Focus control] screen**

This screen is used to adjust the focus of the camera.



**Related Topic**

- [Basic Operation](#)

TP1001125846

## About This Help Guide

---



### Help Guide conventions

In this Help Guide, a smartphone, tablet, or other portable device on which this app is installed is referred to as a “mobile device.”

### Icons in procedures for connecting devices

Steps that display  (App operation icon) indicate an operation performed using this app.

Steps that display  (Mobile device operation icon) indicate an operation performed on a mobile device.

Steps that display  (Camera operation icon) or  (Camera operation icon) indicate an operation performed on a camera.

### Mobile devices described in this Help Guide

This Help Guide describes the operation method when using a Sony Xperia (Android 13) and iPad Pro (iPadOS 16.3.1). The operation method may differ depending on your mobile device.

TP1001125848



Monitor & Control

## Connection Methods and Supported Functions

The following table lists the cameras and their functions that are supported by this app. Click/tap the ✓ mark in the table to display the connection procedure.

- ✓: Supported, –: Not supported, ○: Change/check supported △: Check supported only

### Connection methods

Connection method/Name within app	Camera		
	ILME-FX6/BURANO* <sup>1</sup>	ILME-FX3/ILME-FX30	α9 III* <sup>2</sup>
Wi-Fi connection via Bluetooth pairing/Bluetooth pairing (Wi-Fi)	–	✓	✓
Wi-Fi connection using camera as an AP* <sup>3</sup> (Wi-Fi Direct connection)/Wi-Fi	✓	✓	✓
Wi-Fi connection using wireless LAN router as an AP* <sup>3</sup> /Wi-Fi	✓	✓	✓
Wired LAN connection via router/Wired LAN	✓	–	✓
Wi-Fi tethering* <sup>4</sup> using mobile device as an AP* <sup>3</sup> /Tethering (Wi-Fi)	✓	✓	✓
USB tethering* <sup>4</sup> using mobile device as an AP* <sup>3</sup> /Tethering (USB)	✓	–	–

\*<sup>1</sup> MPC-2610

\*<sup>2</sup> ILCE-9M3

\*<sup>3</sup> Access point (AP): Device that provides SSID for Wi-Fi connection.

\*<sup>4</sup> Tethering (Internet sharing): Function that enables Internet connection via mobile network data communication using the SIM card of a mobile device.

### Recommended connection method by usage method

#### ILME-FX6/MPC-2610

Connection method/Name within app	Usage				
	Standard	Connection from multiple mobile devices* <sup>1</sup>	Stable connection	FTP transfer	Switching between multiple cameras
Wi-Fi connection using camera as an AP (Wi-Fi Direct connection)/Wi-Fi	✓	–	–	–	–
Wi-Fi connection using wireless LAN router as an AP/Wi-Fi	–	✓	–	✓* <sup>2</sup>	✓

Connection method/Name within app	Usage				
	Standard	Connection from multiple mobile devices <sup>*1</sup>	Stable connection	FTP transfer	Switching between multiple cameras
Wired LAN connection via router/Wired LAN	–	✓	✓	✓ <sup>*2</sup>	✓
Wi-Fi tethering with mobile device as an AP/Tethering (Wi-Fi)	–	✓	–	✓ <sup>*2</sup>	✓
USB tethering using mobile device as an AP/Tethering (USB) <sup>*3</sup>	–	–	✓	✓ <sup>*2</sup>	–

### ILME-FX3/ILME-FX30

Connection method/Name within app	Usage	
	Standard	Switching between multiple cameras
Wi-Fi connection via Bluetooth pairing/Bluetooth pairing (Wi-Fi)	✓	–
Wi-Fi connection using camera as an AP (Wi-Fi Direct connection)/Wi-Fi	✓ <sup>*4</sup>	–
Wi-Fi connection using wireless LAN router as an AP/Wi-Fi	–	✓
Wi-Fi tethering with mobile device as an AP/Tethering (Wi-Fi)	–	✓

### ILCE-9M3

Connection method/Name within app	Usage		
	Standard	Stable connection	Switching between multiple cameras
Wi-Fi connection via Bluetooth pairing/Bluetooth pairing (Wi-Fi)	✓	–	–
Wi-Fi connection using camera as an AP (Wi-Fi Direct connection)/Wi-Fi	✓ <sup>*4</sup>	–	–
Wi-Fi connection using wireless LAN router as an AP/Wi-Fi	–	–	✓
Wi-Fi tethering with mobile device as an AP/Tethering (Wi-Fi)	–	–	✓
Wired LAN connection via router/Wired LAN	–	✓	✓

<sup>\*1</sup> ILME-FX6 is supported in firmware version 4.00 and later.

\*2 Must be connected to the Internet.

\*3 Not supported on iPad.

\*4 Use as an alternative method if Bluetooth connection is not successful.

## Supported functions

Supported function		Camera			
		BURANO* <sup>1</sup>	FX6	FX3/FX30	α9 III* <sup>2</sup>
Basic camera operations	Start/stop recording	✓	✓	✓	✓
	Shooting assist function display [Waveform]/[Histogram]/[False color]/[Zebra]	–	–	✓	✓
	Focus control bar (Focus control screen)	✓	✓	✓	✓
	Iris control bar (Focus control screen)	✓	✓	–	–
Change camera settings	[WB]	○	○	○	○
	[ND]	○	○	–	–
	[EV]	–	–	○	○
	[IRIS]	○	○	○	○
	[GAIN]	○	○	–	–
	[ISO/EI]	○	○	○	○
	[SHUTTER]	○	○	○	○
	[IS]	○	–	–	–
	[ZOOM]	○	○	○	○
	[Shooting mode]/[Log shooting]	△	○	○	○
	[Scene file]	○	○	–	–
	[Picture profile]	–	–	○	○
	[Color gamut]	△	○	○	○
	[Base look]/[Select LUT]	○	○	○	○
	[Display LUT]	–	–	○	○
	[Video format]	△	△	○	○
	[Frame rate]	△	△	○	○
[Resolution]/[Record setting]	△	△	○	○	
[Live view quality]	–	–	○	○	

Supported function		Camera			
		BURANO* <sup>1</sup>	FX6	FX3/FX30	α9 III* <sup>2</sup>
Clip operations	Play proxy	✓	✓	–	–
	Import proxy to mobile device	✓	✓	–	–
	Transfer proxy to FTP server	✓	✓	–	–
	Play original clip using proxy	✓	✓	–	–
	Transfer original to FTP server	✓	✓	–	–

\*1 MPC-2610

\*2 ILCE-9M3

TP1001273033

H-479-100-12(1) Copyright 2023 Sony Corporation

## Lenses that Do Not Support Manual Focus Operation by Specifying a Distance

The following lenses do not support manual focus operation by specifying a distance.

- SEL16F28 (16 mm F2.8)
- SEL1855 (18–55 mm F3.5–5.6)
- SEL55210 (55–210 mm F4.5–6.3)
- SEL18200 (18–200 mm F3.5–6.3)
- SEL30M35 (30 mm F3.5)
- SEL24F18Z (24 mm F1.8)
- SEL50F18 (50 mm F1.8)
- SEL1670Z (16–70 mm F4)
- SEL1018 (10–18 mm F4)
- SELP1650 (16–50 mm F3.5–5.6)
- SEL35F28Z (35 mm F2.8)
- SEL2470Z (24–70 mm F4)
- SEL18200LE (18–200 mm F3.5–6.3)
- SEL20F28 (20 mm F2.8)
- SEL35F18 (35 mm F1.8)
- SELP18105G (18–105 mm F4)
- SEL90M28G (90 mm F2.8)
- SEL1850 (18–50 mm F4–5.6)
- SELP18200 (18–200 mm F3.5–6.3)
- SEL55F18Z (55 mm F1.8)
- SEL1635Z (16–35 mm F4)
- SEL50M28 (50 mm F2.8)
- SEL2870 (28–70 mm F3.5–5.6)
- SEL35F14Z (35 mm F1.4)
- SEL28F20 (28 mm F2)
- SELP18110G (18–110 mm F4)
- SEL50F18F (50 mm F1.8)
- SEL100F28GM (100 mm F2.8)\*

\* Distance can be specified only when the macro switching ring is set to "0.85m–∞."

### Hint

- For lenses that do not support manual focus operation by specifying a distance, the focus control bar is displayed in %.

## Connecting Using Bluetooth Pairing (Simple Connection)

You can switch to Wi-Fi automatically and connect a mobile device with the camera automatically by pairing the camera and mobile device using Bluetooth pairing.

In this connection, the camera becomes a Wi-Fi access point.

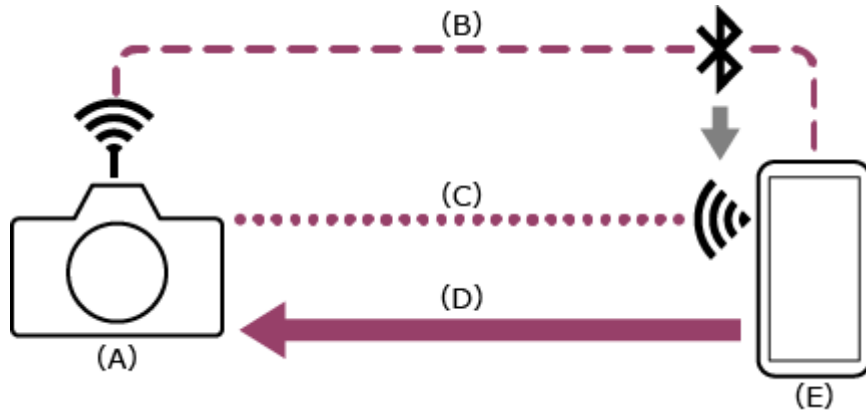

- (A) Camera configured as an access point
- (B) Bluetooth pairing
- (C) Wi-Fi connection
- (D) Remote control
- (E) Mobile device on which this app is installed

- 1 : Press the MENU (Menu) button to display the menu.
- 2 : Select (Network) – [Bluetooth] – [Bluetooth Function] – [On].  
Bluetooth connections are enabled.
- 3 : Select (Network) – [Bluetooth] – [Pairing].  
Bluetooth pairing is enabled.
- 4 : Launch the app and tap (App menu) – [Connect].
- 5 : Select [Bluetooth pairing (Wi-Fi)] on the connection screen.

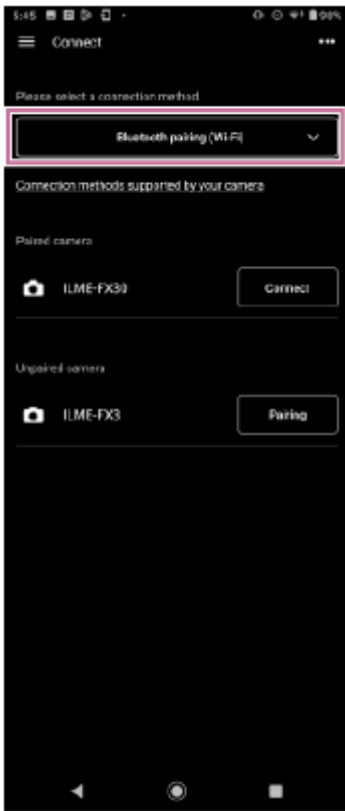

**6** **MAC:** Tap [Connect] for the camera to connect on the connection screen.

- For paired cameras, the [Monitoring] screen appears when connection is established.
- [Unpaired camera] is displayed for unpaired cameras. To pair an unpaired camera, proceed to the next step.

**7** **MAC:** Tap [Pairing] for the camera to pair on the connection screen.

- A dialog appears on the camera screen prompting you to allow pairing.

**8** **📷:** Tap [OK] on the camera screen.

- When pairing or Wi-Fi setup is requested by the mobile device, follow the displayed instructions.

**Note**

- If an access point (tethering) is enabled on a mobile device, disable the setting.
- Do not overlook any notifications. For example, if a “Pairing request” pop-up appears on the screen of an Android mobile device when you tap [OK] on the camera screen, the pop-up will disappear after a few seconds.

## If you have trouble connecting

Refer to the [Monitor & Control support page](#).

## Related Topic

- [Connecting Using Wi-Fi to a Camera Configured as an Access Point \(Wi-Fi Direct connection\) \(ILME-FX3/ILME-FX30/ILCE-9M3\)](#)
- [Connecting Using Wi-Fi to a Mobile Device Configured as an Access Point \(Tethering/Internet Sharing\) \(ILME-FX3/ILME-FX30/ILCE-9M3\)](#)
- [Connecting Using Wi-Fi via Wireless LAN Router Configured as an Access Point \(ILME-FX3/ILME-FX30/ILCE-9M3\)](#)





## Connecting Using Wi-Fi to a Camera Configured as an Access Point (Wi-Fi Direct connection) (ILME-FX3/ILME-FX30/ILCE-9M3)

You can connect to a camera from a mobile device using Wi-Fi (Wi-Fi Direct connection) if the camera is configured as an access point.

- In a Wi-Fi Direct connection, only one mobile device can be connected to the camera at a time.

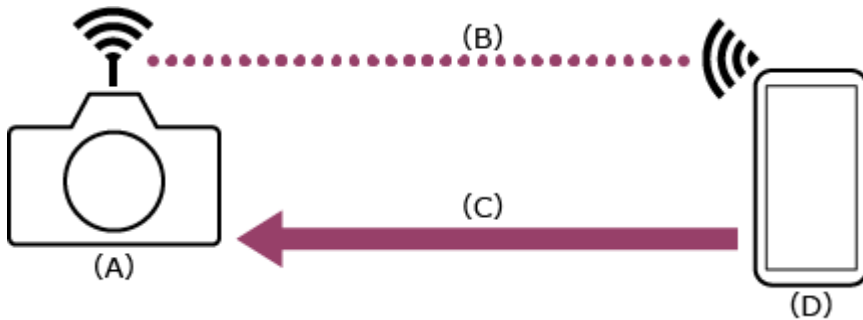

- (A) Camera configured as an access point  
 (B) Wi-Fi connection  
 (C) Remote control  
 (D) Mobile device on which this app is installed

- 1 : Press the MENU (Menu) button to display the menu.
- 2 : Select (Network) – [Wi-Fi] – [Wi-Fi Connect] – [Off].
- 3 : Select (Network) – [Cnct./PC Remote] – [PC Remote Function] – [Wi-Fi Direct Info.] – [OK].
- 4 : Leave the SSID and password displayed in step 3 on the screen.
- 5 : Configure the following settings on the mobile device to connect the mobile device to the camera access point.

### On Android:

1. Select [Settings] – [Network & internet] – [Internet].
2. Enable [Wi-Fi].
3. Select the camera access point from the network list.
4. Enter the password displayed in step 4.

### On iOS/iPadOS:

1. Select [Settings] – [Wi-Fi].
2. Enable [Wi-Fi].
3. Select the camera access point from the network list.
4. Enter the password displayed in step 4.

### Note

- The menu structure may vary depending on your mobile device.
- If an access point (tethering) is enabled on a mobile device, disable the setting.

6 **M&C**: Launch the app and tap  (App menu) – [Connect].

7 **M&C**: Select [Wi-Fi] on the connection screen.

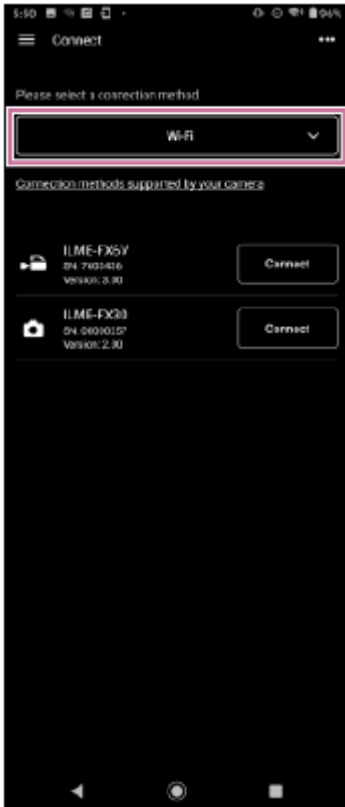

8 **M&C**: Tap [Connect] for the camera to connect on the connection screen.

## If you have trouble connecting

Refer to the [Monitor & Control support page](#).

---

### Related Topic

- [Connecting Using Bluetooth Pairing \(Simple Connection\)](#)
- [Connecting Using Wi-Fi to a Mobile Device Configured as an Access Point \(Tethering/Internet Sharing\) \(ILME-FX3/ILME-FX30/ILCE-9M3\)](#)
- [Connecting Using Wi-Fi via Wireless LAN Router Configured as an Access Point \(ILME-FX3/ILME-FX30/ILCE-9M3\)](#)
- [Authenticating Access When Connecting to a Camera \(ILME-FX3/ILME-FX30/ILCE-9M3\)](#)

TP1001125850

## Connecting Using Wi-Fi to a Mobile Device Configured as an Access Point (Tethering/Internet Sharing) (ILME-FX3/ILME-FX30/ILCE-9M3)

You can connect a camera to a mobile device using Wi-Fi if the mobile device is configured as an access point.

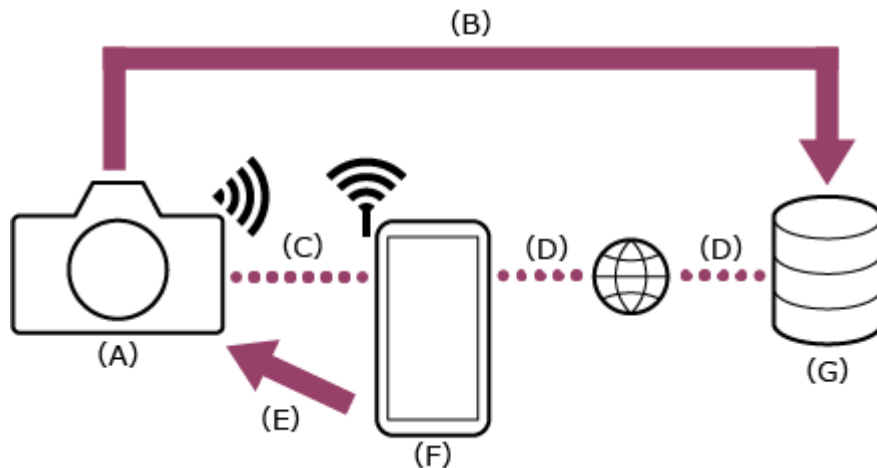

- (A) Camera
- (B) File transfer
- (C) Wi-Fi connection
- (D) Internet connection
- (E) Remote control
- (F) Mobile device on which this app is installed (access point)
- (G) Server

### 1 : Configure the following settings on the mobile device to enable as an access point for tethering.

#### On Android:

1. Select [Settings] – [Network & internet] – [Hotspot & tethering] – [Portable hotspot].
2. Enable [Use Wi-Fi hotspot].
3. Make a memo of the mobile device name and password displayed on the screen.

#### On iOS/iPadOS:

1. Select [Settings] – [Personal Hotspot].
2. Enable [Allow Others to Join].
3. Make a memo of the mobile device name and password displayed on the screen.

#### Note

- The menu structure may vary depending on your mobile device.
- If Wi-Fi is enabled on a mobile device, disable the setting.

### 2 : Press the MENU (Menu) button on the camera to display the menu.

### 3 : Select (Network) – [Wi-Fi] – [Wi-Fi Connect] – [On].

4 : Select [OK].

5 : Select [Access Point Set.].

6 : Select the mobile device access point and enter the password.

If the connection is successful, the access point manual registration screen appears.

7 : Select [OK] on the screen.

#### Hint

- On an iOS/iPadOS mobile device, the time and status bar will turn green when the camera is tethered to your mobile device.

8 : Select  (Network) – [Cnct./PC Remote] – [PC Remote Function] – [PC Remote] – [On].

The PC remote function (enabling camera operation from a mobile device) is enabled.

9 : Select [Access Authen. Info] on the screen.

The user name and password appears.

10 : Launch the app and tap  (App menu) – [Connect].

11 : Select [Tethering (Wi-Fi)]\* on the connection screen.

\* On Android, [Tethering (Wi-Fi)] is displayed. On iOS/iPadOS, [Tethering (Wi-Fi/USB)] is displayed.

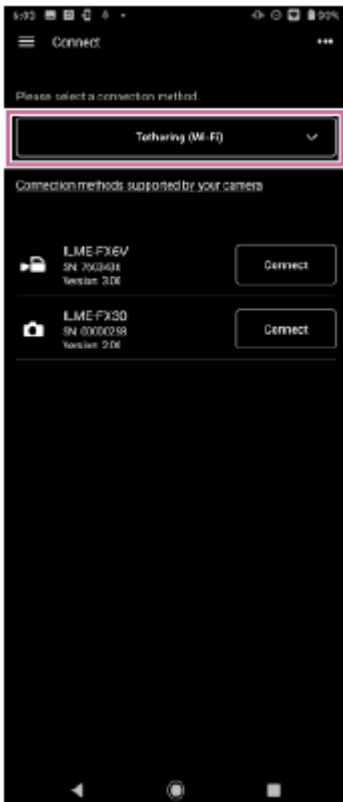

12 : Tap [Connect] for the camera to connect on the connection screen.

## Hint

- If the same camera model is displayed multiple times, changing the device name makes it easier for you to distinguish the cameras.

### 13 **M&C:** Authenticate access for the connection to enable encrypted communication with the camera.

If access authentication is set to “On” on the camera, you must enter your access credentials (user name and password) when connecting for the first time. If you are prompted to enter a user name and password, perform access authentication as described in the “Authenticating Access When Connecting to a Camera (ILME-FX3/ILME-FX30/ILCE-9M3)” related topic.

## If you have trouble connecting

Refer to the [Monitor & Control support page](#).

---

### Related Topic

- [Connecting Using Bluetooth Pairing \(Simple Connection\)](#)
- [Connecting Using Wi-Fi to a Camera Configured as an Access Point \(Wi-Fi Direct connection\) \(ILME-FX3/ILME-FX30/ILCE-9M3\)](#)
- [Connecting Using Wi-Fi via Wireless LAN Router Configured as an Access Point \(ILME-FX3/ILME-FX30/ILCE-9M3\)](#)
- [Authenticating Access When Connecting to a Camera \(ILME-FX3/ILME-FX30/ILCE-9M3\)](#)

TP1001125851

## Connecting Using Wi-Fi via Wireless LAN Router Configured as an Access Point (ILME-FX3/ILME-FX30/ILCE-9M3)

You can connect a camera and a mobile device to the same wireless LAN router access point using Wi-Fi to connect the camera and mobile device.

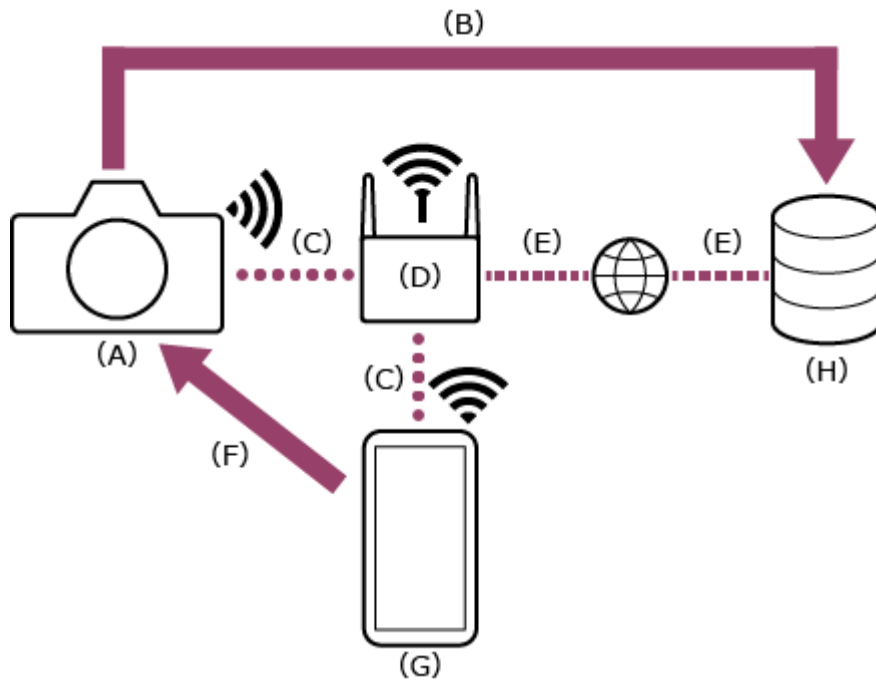

- (A) Camera
- (B) File transfer
- (C) Wi-Fi connection
- (D) Access point
- (E) Internet connection
- (F) Remote control
- (G) Mobile device on which this app is installed
- (H) Server

- 1 : Press the MENU (Menu) button to display the menu.
  - 2 : Select (Network) – [Wi-Fi] – [Wi-Fi Connect] – [On].
  - 3 : Select [OK].
  - 4 : Select [Access Point Set.].
    - To connect using the WPS push button of an access point, select [WPS Push].
  - 5 : Select the wireless LAN router access point to connect and enter the password.  
If the connection is successful, the access point manual registration screen appears.
- : Select [OK] on the screen.

7 : Select  (Network) – [Cnct./PC Remote] – [PC Remote Function] – [PC Remote] – [On].

The PC remote function (enabling camera operation from a mobile device) is enabled.

8 : Select [Access Authen. Info] on the screen.

The user name and password appears.

9 : Configure the following settings on the mobile device to connect the mobile device to the wireless LAN router access point.

#### On Android:

1. Select [Settings] – [Network & internet] – [Internet].
2. Enable [Wi-Fi].
3. Select the access point to which the camera was connected in step 4 from the network list.

#### On iOS/iPadOS:

1. Select [Settings] – [Wi-Fi].
2. Enable [Wi-Fi].
3. Select the access point to which the camera was connected in step 4 from the network list.

#### Note

- The menu structure may vary depending on your mobile device.
- If an access point (tethering) is enabled on a mobile device, disable the setting.

10 : Launch the app and tap  (App menu) – [Connect].

11 : Select [Wi-Fi] on the connection screen.

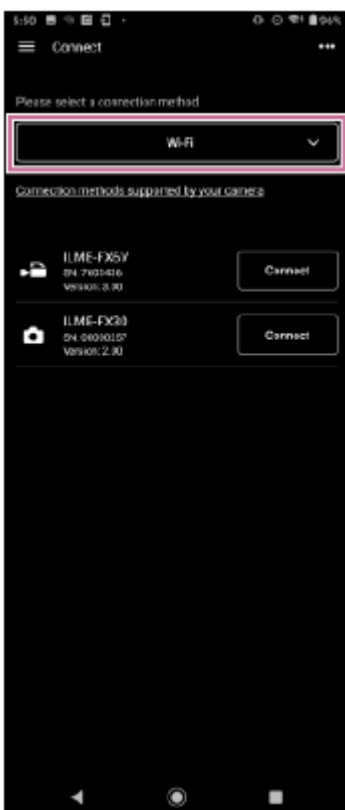

**12** **M&C:** Tap [Connect] for the camera to connect on the connection screen.

#### Hint

- If the same camera model is displayed multiple times, changing the device name makes it easier for you to distinguish the cameras.

**13** **M&C:** Authenticate access for the connection to enable encrypted communication with the camera.

If access authentication is set to “On” on the camera, you must enter your access credentials (user name and password) when connecting for the first time. If you are prompted to enter a user name and password, perform access authentication as described in the “Authenticating Access When Connecting to a Camera (ILME-FX3/ILME-FX30/ILCE-9M3)” related topic.

## If you have trouble connecting

Refer to the [Monitor & Control support page](#).

---

### Related Topic

- [Connecting Using Bluetooth Pairing \(Simple Connection\)](#)
- [Connecting Using Wi-Fi to a Camera Configured as an Access Point \(Wi-Fi Direct connection\) \(ILME-FX3/ILME-FX30/ILCE-9M3\)](#)
- [Connecting Using Wi-Fi to a Mobile Device Configured as an Access Point \(Tethering/Internet Sharing\) \(ILME-FX3/ILME-FX30/ILCE-9M3\)](#)
- [Authenticating Access When Connecting to a Camera \(ILME-FX3/ILME-FX30/ILCE-9M3\)](#)

TP1001125852



## Connecting by Wired LAN via a Router (ILCE-9M3)

You can connect a camera and a mobile device by connecting the camera and mobile device via wired LAN to the same router.

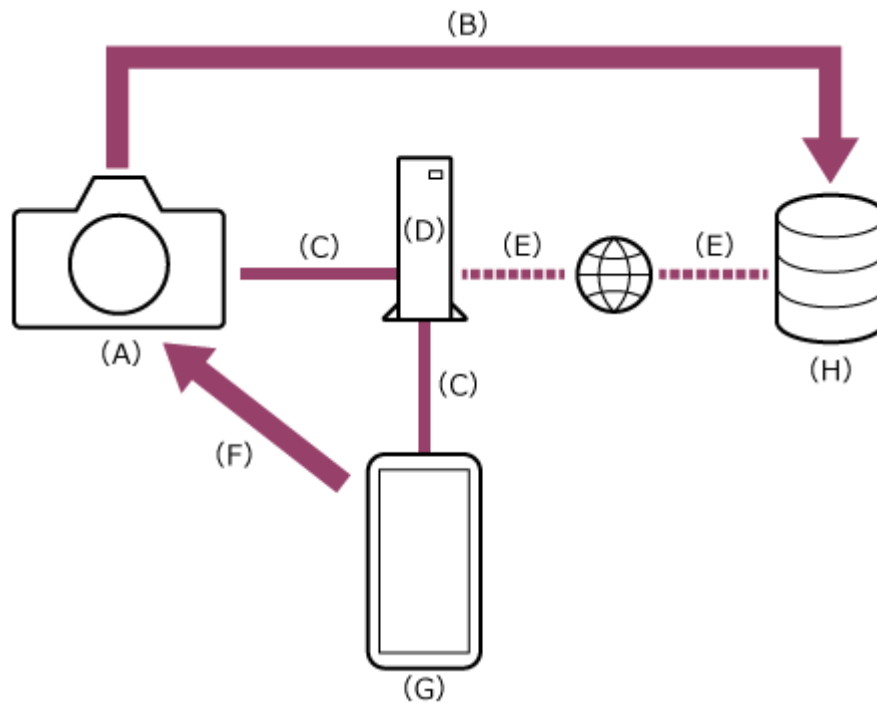

- (A) Camera
- (B) File transfer
- (C) Wired LAN connection
- (D) Router
- (E) Internet connection
- (F) Remote control
- (G) Mobile device on which this app is installed
- (H) Server

- 1 : Connect a camera and mobile device to the same router.
- 2 : Press the MENU (Menu) button to display the menu.
- 3 : Select (Network) – [Wired LAN] – [Wired LAN Connect] – [On].
- 4 : Select (Network) – [Cnct./PC Remote] – [PC Remote Function] – [PC Remote] – [On].  
PC remote connections are enabled.
- 5 : Select [Access Authen. Info] on the screen.  
The user name and password appears.
- 6 : Launch the app and tap (App menu) – [Connect].

**7** **M&C:** Select [Wired LAN] on the connection screen.

**8** **M&C:** Tap [Connect] for the camera to connect on the connection screen.

**9** **M&C:** Authenticate access for the connection to enable encrypted communication with the camera.

If access authentication is set to [On] on the camera, you must enter your access credentials (user name and password) when connecting for the first time. If you are prompted to enter a user name and password, perform access authentication as described in “Authenticating Access When Connecting to a Camera (ILME-FX3/ILME-FX30/ILCE-9M3).”

---

### Related Topic

- [Authenticating Access When Connecting to a Camera \(ILME-FX3/ILME-FX30/ILCE-9M3\)](#)

TP1001477523

## Monitor &amp; Control

## Authenticating Access When Connecting to a Camera (ILME-FX3/ILME-FX30/ILCE-9M3)

Unless encrypted communication is disabled on the camera, you must enter your user name and password when connecting for the first time to enable encrypted communication with the camera. When you tap the camera to connect when configuring the connection, you will be prompted to enter your user name and password on the following access authentication screen.



You can check the user name and password for access authentication using the following procedure.

- 1 : Select (Network) – [Network Option] – [Access Authen. Info].
- 2 : Display the user name and password.
- 3 : Tap [Manual input] on the access authentication screen of the app.
- 4 : Enter the user name and password, and tap [Connect].

If access authentication is successful, the devices are connected.

### Hint

- If encrypted communication is disabled on the camera, the (Network) – [Cnct./PC Remote] – [PC Remote Function] – [Pairing] step is required.
- The ILME-FX3/ILME-FX30/ILCE-9M3 does not support configuration by scanning a QR code.

- This setting is only required when you connect for the first time. Subsequently, the app uses the cached user name and password for authentication, hence access authentication is no longer required.

TP1001125854

H-479-100-12(1) Copyright 2023 Sony Corporation

## Setup When Connecting to MPC-2610 Using Wi-Fi

---

Before connecting to MPC-2610 using Wi-Fi, be sure to configure the following settings on MPC-2610.

1 : Select [Network] – [Network Setup] – [LAN Type Select].

2 : Select [LAN Type Select] – [WLAN (AP Mode)] or [WLAN (ST Mode)].

To connect in access point mode, select [WLAN (AP Mode)].

To connect in station mode (camera connects to a wireless LAN access point as a client), select [WLAN (ST Mode)].

TP1001426002

## Connecting Using Wi-Fi to a Camera Configured as an Access Point (Wi-Fi Direct connection) (ILME-FX6/MPC-2610)

You can connect to a camera from a mobile device using Wi-Fi (Wi-Fi Direct connection) if the camera is configured as an access point.

- In a Wi-Fi Direct connection, only one mobile device can be connected to the camera at a time.

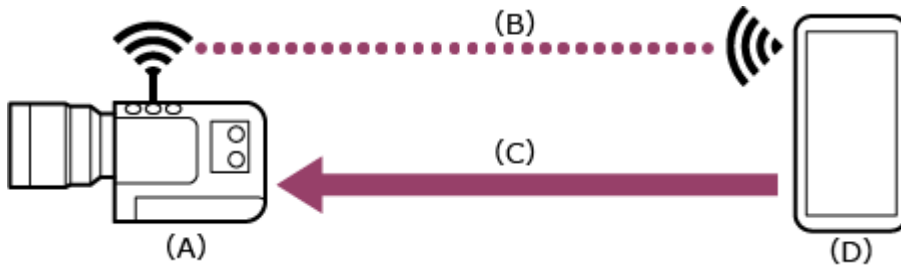

- (A) Camera configured as an access point
- (B) Wi-Fi connection
- (C) Remote control
- (D) Mobile device on which this app is installed

- 1 : **Press and hold the MENU (Menu) button to display the menu.**
- 2 : **Configure the following settings if a user name and password have not been configured on the camera.**
  1. Set the user name.
    - ILME-FX6: [Network] – [Access Authentication] – [User Name]
    - MPC-2610: [Network] – [Network Setup] – [User Name]
  2. Automatically generate a new password.
    - ILME-FX6: [Network] – [Access Authentication] – [Generate Password]
    - MPC-2610: [Network] – [Network Setup] – [Generate Password]

### Hint

- You can also configure a password manually using the following menu items.
  - ILME-FX6: [Network] – [Access Authentication] – [Input Password]
  - MPC-2610: [Network] – [Network Setup] – [Input Password]
- The user name and password can be viewed as text and QR code.
  - ILME-FX6: [Network] – [Access Authentication] – [Show Settings]
  - MPC-2610: [Network] – [Network Setup] – [Show Authentication]

### Note

- Take care that the QR code and password cannot be viewed by other people.

- 3 : **Select [Network] – [Wireless LAN] – [Setting] – [Access Point Mode].**

Access point connections are enabled.

4 : Display the access point information using [Network] – [AP Mode Settings] – [Camera SSID & Password].

5 : Configure the following settings on the mobile device to connect the mobile device to the camera access point.

**On Android:**

1. Select [Settings] – [Network & internet] – [Internet].
2. Enable [Wi-Fi].
3. Select the camera access point from the network list.
4. Enter the password displayed in step 4.

**On iOS/iPadOS:**

1. Select [Settings] – [Wi-Fi].
2. Enable [Wi-Fi].
3. Select the camera access point from the network list.
4. Enter the password displayed in step 4.

**Note**

- The menu structure may vary depending on your mobile device.

6 : Launch the app and tap  (App menu) – [Connect].

7 : Select [Wi-Fi] on the connection screen.

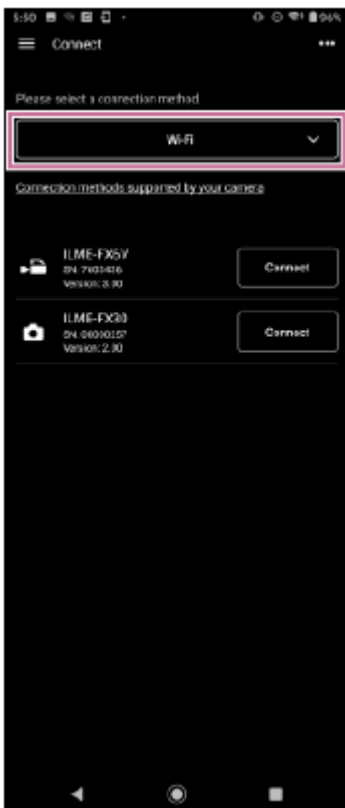

**8**  Tap [Connect] for the camera to connect on the connection screen.

**9**  **Authenticate access for the connection to enable encrypted communication with the camera.**

- Access authentication is required when you connect for the first time. Perform access authentication as described in the “Authenticating Access When Connecting to a Camera (ILME-FX6/MPC-2610)” related topic.

## If you have trouble connecting

Refer to the [Monitor & Control support page](#).

---

### Related Topic

- [Connecting Using Wi-Fi to a Mobile Device Configured as an Access Point \(Tethering/Internet Sharing\) \(ILME-FX6/MPC-2610\)](#)
- [Connecting Using Wi-Fi via Wireless LAN Router Configured as an Access Point \(ILME-FX6/MPC-2610\)](#)
- [Connecting by Wired LAN via a Router \(ILME-FX6/MPC-2610\)](#)
- [Connecting Using USB to a Mobile Device Configured as an Access Point \(Tethering\) \(ILME-FX6/MPC-2610\)](#)
- [Authenticating Access When Connecting to a Camera \(ILME-FX6/MPC-2610\)](#)

TP1001125855



## Connecting Using Wi-Fi to a Mobile Device Configured as an Access Point (Tethering/Internet Sharing) (ILME-FX6/MPC-2610)

You can connect to a mobile device using Wi-Fi if the device is configured as an access point.

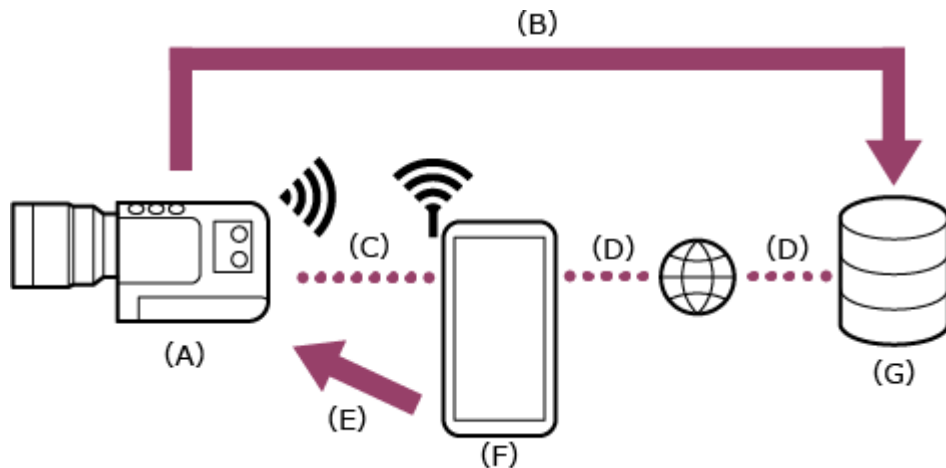

- (A) Camera
- (B) File transfer
- (C) Wi-Fi connection
- (D) Internet connection
- (E) Remote control
- (F) Mobile device on which this app is installed (access point)
- (G) Server

### 1 Configure the following settings on the mobile device to enable as an access point for tethering.

#### On Android:

1. Select [Settings] – [Network & internet] – [Hotspot & tethering] – [Portable hotspot].
2. Enable [Use Wi-Fi hotspot].
3. Make a memo of the network name (SSID) and password displayed on the screen.

#### On iOS/iPadOS:

1. Select [Settings] – [Personal Hotspot].
2. Enable [Allow Others to Join].
3. Make a memo of the mobile device name and password displayed on the screen.

#### Note

- The menu structure may vary depending on your mobile device.
- When the wireless security protocol for Wi-Fi tethering on a mobile device is WPA3, the access point cannot be detected from ILME-FX6/MPC-2610.
- To detect the mobile device from ILME-FX6/MPC-2610, change the security protocol of the mobile device to WPA2 or WPA2/WPA3.

### 2 Press and hold the MENU (Menu) button on the camera to display the menu.

**3** : **Configure the following settings if a user name and password have not been configured on the camera.**

1. Set the user name.
  - ILME-FX6: [Network] – [Access Authentication] – [User Name]
  - MPC-2610: [Network] – [Network Setup] – [User Name]
2. Automatically generate a new password.
  - ILME-FX6: [Network] – [Access Authentication] – [Generate Password]
  - MPC-2610: [Network] – [Network Setup] – [Generate Password]

**Hint**

- You can also configure a password manually using the following menu items.
  - ILME-FX6: [Network] – [Access Authentication] – [Input Password]
  - MPC-2610: [Network] – [Network Setup] – [Input Password]
- The user name and password can be viewed as text and QR code.
  - ILME-FX6: [Network] – [Access Authentication] – [Show Settings]
  - MPC-2610: [Network] – [Network Setup] – [Show Authentication]

**Note**

- Take care that the QR code and password cannot be viewed by other people.

**4** : **Select [Network] – [Wireless LAN] – [Setting] – [Station Mode].**

Station mode (camera connects to a wireless LAN access point as a client) is enabled.

**5** : **Select [Network] – [ST Mode Settings] – [Camera Remote Control] – [Enable].**

Camera remote control is enabled.

**6** : **Execute [Network] – [ST Mode Settings] – [Scan Networks].**

**7** : **Select the mobile device access point to connect, and enter the password.**

**8** : **Select [Connect] on the screen.**

**Hint**

- On an iOS/iPadOS mobile device, the time and status bar will turn green when the camera is tethered to your mobile device.

**9** : **Launch the app and tap  (App menu) – [Connect].**

**10** : **Select [Tethering (Wi-Fi)]\* on the connection screen.**

\* On Android, [Tethering (Wi-Fi)] is displayed. On iOS/iPadOS, [Tethering (Wi-Fi/USB)] is displayed.

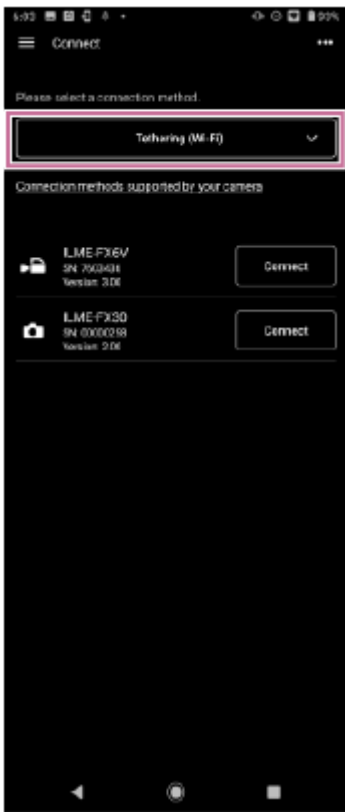

**11** **M&C:** Tap [Connect] for the camera to connect on the connection screen.

**12** **M&C:** Authenticate access for the connection to enable encrypted communication with the camera.

- Access authentication is required when you connect for the first time. Perform access authentication as described in the “Authenticating Access When Connecting to a Camera (ILME-FX6/MPC-2610)” related topic.

## If you have trouble connecting

Refer to the [Monitor & Control support page](#).

### Related Topic

- [Connecting Using Wi-Fi to a Camera Configured as an Access Point \(Wi-Fi Direct connection\) \(ILME-FX6/MPC-2610\)](#)
- [Connecting Using Wi-Fi via Wireless LAN Router Configured as an Access Point \(ILME-FX6/MPC-2610\)](#)
- [Connecting by Wired LAN via a Router \(ILME-FX6/MPC-2610\)](#)
- [Connecting Using USB to a Mobile Device Configured as an Access Point \(Tethering\) \(ILME-FX6/MPC-2610\)](#)
- [Authenticating Access When Connecting to a Camera \(ILME-FX6/MPC-2610\)](#)

TP1001125856

## Connecting Using Wi-Fi via Wireless LAN Router Configured as an Access Point (ILME-FX6/MPC-2610)

You can connect a camera and a mobile device to the same wireless LAN router access point using Wi-Fi to connect the camera and mobile device.

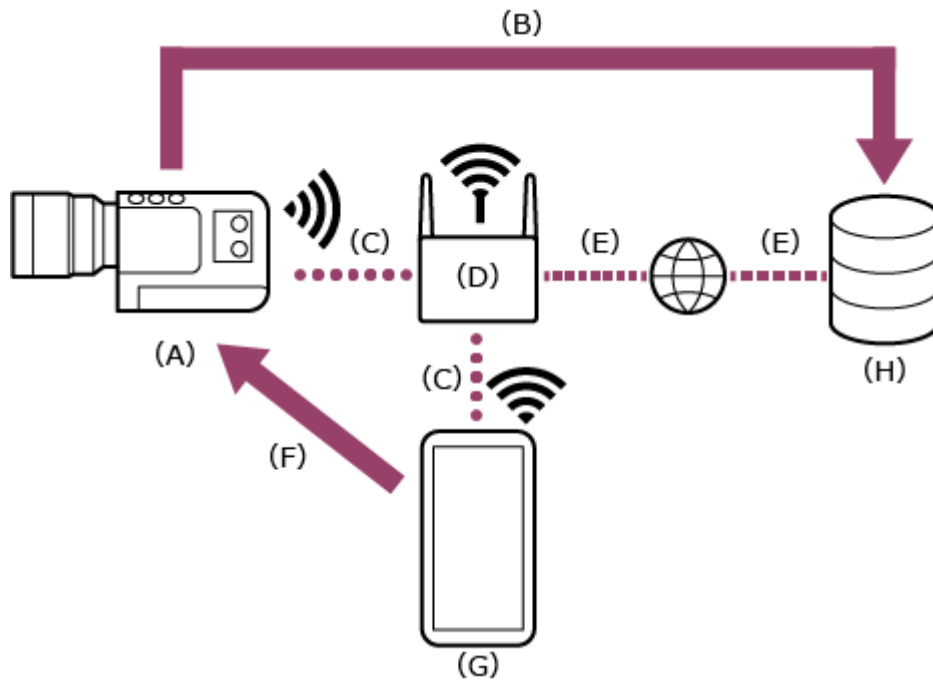

- (A) Camera
- (B) File transfer
- (C) Wi-Fi connection
- (D) Access point
- (E) Internet connection
- (F) Remote control
- (G) Mobile device on which this app is installed
- (H) Server

- 1 : **Press and hold the MENU (Menu) button to display the menu.**
- 2 : **Configure the following settings if a user name and password have not been configured on the camera.**
  1. Set the user name.
    - ILME-FX6: [Network] – [Access Authentication] – [User Name]
    - MPC-2610: [Network] – [Network Setup] – [User Name]
  2. Automatically generate a new password.
    - ILME-FX6: [Network] – [Access Authentication] – [Generate Password]
    - MPC-2610: [Network] – [Network Setup] – [Generate Password]

### Hint

- You can also configure a password manually using the following menu items.
  - ILME-FX6: [Network] – [Access Authentication] – [Input Password]

– MPC-2610: [Network] – [Network Setup] – [Input Password]

- The user name and password can be viewed as text and QR code.
- ILME-FX6: [Network] – [Access Authentication] – [Show Settings]
- MPC-2610: [Network] – [Network Setup] – [Show Authentication]

### Note

- Take care that the QR code and password cannot be viewed by other people.
- When the wireless security protocol for an access point is WPA3, the access point cannot be detected from ILME-FX6/MPC-2610.
- To detect the access point from ILME-FX6/MPC-2610, change the security protocol of the access point to WPA2 or WPA2/WPA3.

### 3 : Select [Network] – [Wireless LAN] – [Setting] – [Station Mode].

Station mode (camera connects to a wireless LAN access point as a client) is enabled.

### 4 : Select [Network] – [ST Mode Settings] – [Camera Remote Control] – [Enable].

Camera remote control is enabled.

### 5 : Connect to the wireless LAN router access point using [Network] – [ST Mode Settings] – [Scan Networks] or [Manual Register].

- For details, refer to the operating instructions for the ILME-FX6/MPC-2610.

### 6 : Configure the following settings on the mobile device to connect the mobile device to the wireless LAN router access point.

#### On Android:

1. Select [Settings] – [Network & internet] – [Internet].
2. Enable [Wi-Fi].
3. Select the access point to which the camera was connected in step 5 from the network list.

#### On iOS/iPadOS:

1. Select [Settings] – [Wi-Fi].
2. Enable [Wi-Fi].
3. Select the access point to which the camera was connected in step 5 from the network list.

### Note

- The menu structure may vary depending on your mobile device.

### 7 : Launch the app and tap (App menu) – [Connect].

### 8 : Select [Wi-Fi] on the connection screen.

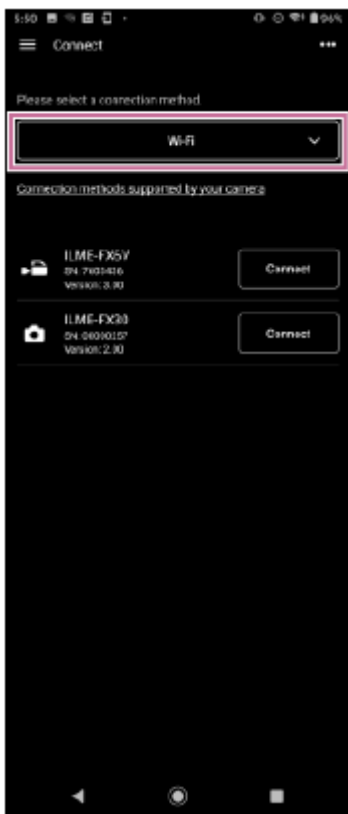

**9** **M&C**: Tap [Connect] for the camera to connect on the connection screen.

**10** **M&C**: Authenticate access for the connection to enable encrypted communication with the camera.

- Access authentication is required when you connect for the first time. Perform access authentication as described in the “Authenticating Access When Connecting to a Camera (ILME-FX6/MPC-2610)” related topic.

## If you have trouble connecting

Refer to the [Monitor & Control support page](#).

### Related Topic



- [Connecting Using Wi-Fi to a Camera Configured as an Access Point \(Wi-Fi Direct connection\) \(ILME-FX6/MPC-2610\)](#)
- [Connecting Using Wi-Fi to a Mobile Device Configured as an Access Point \(Tethering/Internet Sharing\) \(ILME-FX6/MPC-2610\)](#)
- [Connecting by Wired LAN via a Router \(ILME-FX6/MPC-2610\)](#)
- [Connecting Using USB to a Mobile Device Configured as an Access Point \(Tethering\) \(ILME-FX6/MPC-2610\)](#)
- [Authenticating Access When Connecting to a Camera \(ILME-FX6/MPC-2610\)](#)

TP1001125857

## Setup When Connecting to MPC-2610 Using Wired LAN

---

Before connecting to MPC-2610 using wired LAN, be sure to configure the following settings on MPC-2610.

- 1 : Select [Network] – [Network Setup] – [LAN Type Select].
- 2 : Select [LAN Type Select] – [Wired LAN].



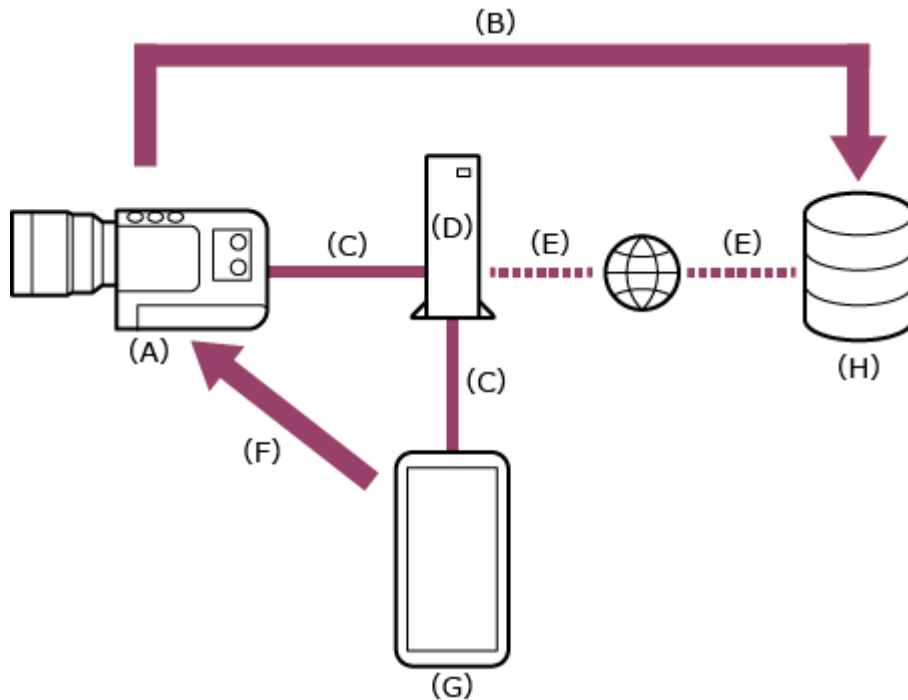

TP1001426003

## Connecting by Wired LAN via a Router (ILME-FX6/MPC-2610)

You can connect a camera and a mobile device by connecting the camera and mobile device via wired LAN to the same router.



- (A) Camera
- (B) File transfer
- (C) Wired LAN connection
- (D) Router
- (E) Internet connection
- (F) Remote control
- (G) Mobile device on which this app is installed
- (H) Server

- 1  : Connect a camera and mobile device to the same router.
- 2 : **Press and hold** the MENU (Menu) button to display the menu.
- 3 : Configure the following settings if a user name and password have not been configured on the camera.
  1. Set the user name.
    - ILME-FX6: [Network] – [Access Authentication] – [User Name]
    - MPC-2610: [Network] – [Network Setup] – [User Name]
  2. Automatically generate a new password.
    - ILME-FX6: [Network] – [Access Authentication] – [Generate Password]
    - MPC-2610: [Network] – [Network Setup] – [Generate Password]

**Hint**



- You can also configure a password manually using the following menu items.
  - ILME-FX6: [Network] – [Access Authentication] – [Input Password]
  - MPC-2610: [Network] – [Network Setup] – [Input Password]
- The user name and password can be viewed as text and QR code.
  - ILME-FX6: [Network] – [Access Authentication] – [Show Settings]
  - MPC-2610: [Network] – [Network Setup] – [Show Authentication]

### Note

- Take care that the QR code and password cannot be viewed by other people.

4 : Select [Network] – [Wired LAN] – [Setting] – [On].

Wired LAN connections are enabled.

5 : Select [Network] – [Wired LAN] – [Camera Remote Control] – [Enable].

Camera remote control is enabled.

6 : Launch the app and tap  (App menu) – [Connect].

7 : Select [Wired LAN] on the connection screen.

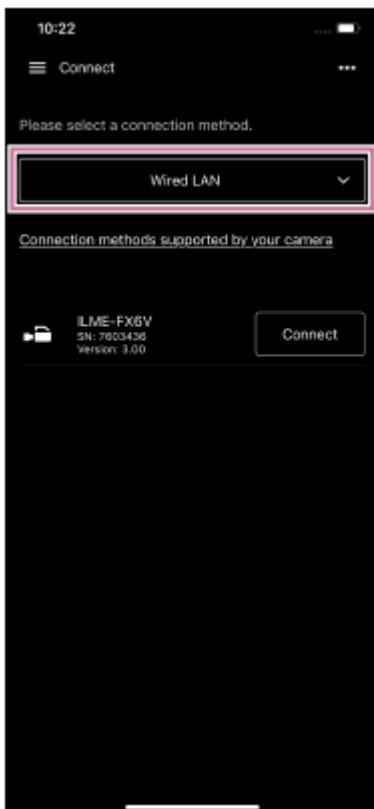

8 : Tap [Connect] for the camera to connect on the connection screen.

9 : Authenticate access for the connection to enable encrypted communication with the camera.

- Access authentication is required when you connect for the first time. Perform access authentication as described in the “Authenticating Access When Connecting to a Camera (ILME-FX6/MPC-2610)” related topic.

## If you have trouble connecting

Refer to the [Monitor & Control support page](#).

---

### Related Topic

- [Connecting Using Wi-Fi to a Camera Configured as an Access Point \(Wi-Fi Direct connection\) \(ILME-FX6/MPC-2610\)](#)
- [Connecting Using Wi-Fi to a Mobile Device Configured as an Access Point \(Tethering/Internet Sharing\) \(ILME-FX6/MPC-2610\)](#)
- [Connecting Using USB to a Mobile Device Configured as an Access Point \(Tethering\) \(ILME-FX6/MPC-2610\)](#)
- [Authenticating Access When Connecting to a Camera \(ILME-FX6/MPC-2610\)](#)

TP1001125858

H-479-100-12(1) Copyright 2023 Sony Corporation

## Connecting Using USB to a Mobile Device Configured as an Access Point (Tethering) (ILME-FX6/MPC-2610)

You can connect a camera and a mobile device using USB tethering if the mobile device is configured as an access point.

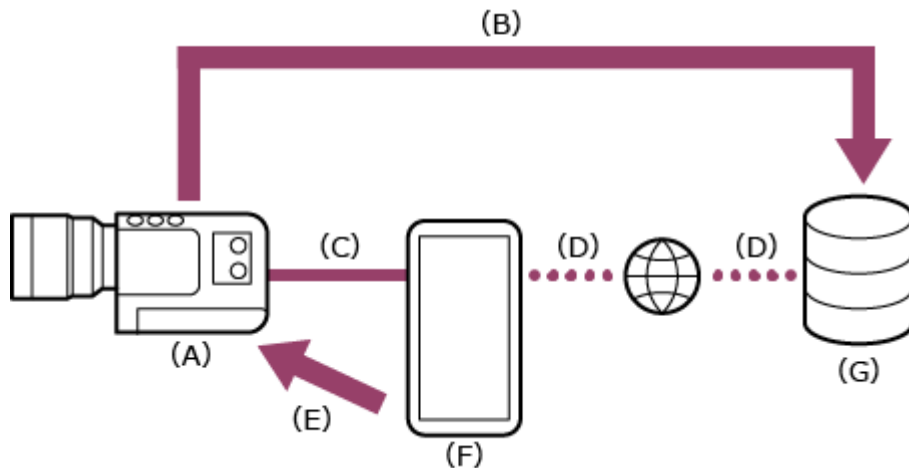

- (A) Camera
- (B) File transfer
- (C) USB connection
- (D) Internet connection (Wi-Fi connection)
- (E) Remote control
- (F) Mobile device on which this app is installed (access point)
- (G) Server

1. Press and hold the MENU (Menu) button to display the menu.
2. Configure the following settings if a user name and password have not been configured on the camera.
  1. Set the user name.
    - ILME-FX6: [Network] – [Access Authentication] – [User Name]
    - MPC-2610: [Network] – [Network Setup] – [User Name]
  2. Automatically generate a new password.
    - ILME-FX6: [Network] – [Access Authentication] – [Generate Password]
    - MPC-2610: [Network] – [Network Setup] – [Generate Password]

### Hint

- You can also configure a password manually using the following menu items.
  - ILME-FX6: [Network] – [Access Authentication] – [Input Password]
  - MPC-2610: [Network] – [Network Setup] – [Input Password]
- The user name and password can be viewed as text and QR code.
  - ILME-FX6: [Network] – [Access Authentication] – [Show Settings]
  - MPC-2610: [Network] – [Network Setup] – [Show Authentication]

### Note

- Take care that the QR code and password cannot be viewed by other people.

3 : Select [Network] – [Modem] – [Setting] – [On].

Modem connections are enabled.

4 : Select [Network] – [Modem] – [Camera Remote Control] – [Enable].

Camera remote control via a modem is enabled.

5 : Connect the mobile device to the USB Type-C connector of the camera using a USB cable.

6 : Configure the following settings on the mobile device to enable as an access point for tethering.

#### On Android:

1. On the access permission screen, select [ALLOW].
2. Select [Settings] – [Network & internet] – [Hotspot & tethering].
3. Enable [USB tethering].

#### On iOS:

1. On the access permission screen, select [Allow].
2. Select [Settings] – [Personal Hotspot].
3. Enable [Allow Others to Join].

### Note

- Not supported on iPad.
- The menu structure may vary depending on your mobile device.

7 : Launch the app and tap  (App menu) – [Connect].

8 : Select [Tethering (USB)] on the connection screen.

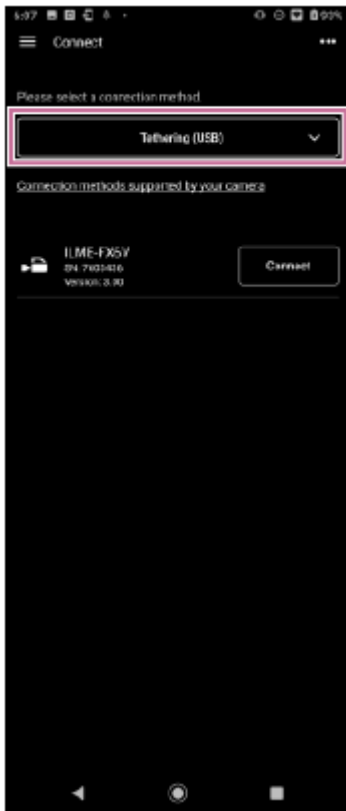

**9** **M&C:** Tap [Connect] for the camera to connect on the connection screen.

**10** **M&C:** Authenticate access for the connection to enable encrypted communication with the camera.

- Access authentication is required when you connect for the first time. Perform access authentication as described in the “Authenticating Access When Connecting to a Camera (ILME-FX6/MPC-2610)” related topic.

### If you have trouble connecting

Refer to the [Monitor & Control support page](#).

### Related Topic

- [Connecting Using Wi-Fi to a Camera Configured as an Access Point \(Wi-Fi Direct connection\) \(ILME-FX6/MPC-2610\)](#)
- [Connecting Using Wi-Fi to a Mobile Device Configured as an Access Point \(Tethering/Internet Sharing\) \(ILME-FX6/MPC-2610\)](#)
- [Connecting Using Wi-Fi via Wireless LAN Router Configured as an Access Point \(ILME-FX6/MPC-2610\)](#)
- [Connecting by Wired LAN via a Router \(ILME-FX6/MPC-2610\)](#)
- [Authenticating Access When Connecting to a Camera \(ILME-FX6/MPC-2610\)](#)

TP1001125859

## Authenticating Access When Connecting to a Camera (ILME-FX6/MPC-2610)

Access authentication setup is required to enable encrypted communication with the camera when you connect for the first time. When you tap the camera that you want to connect, you will be prompted to enter your user name and password or to scan a QR code on the following access authentication screen.

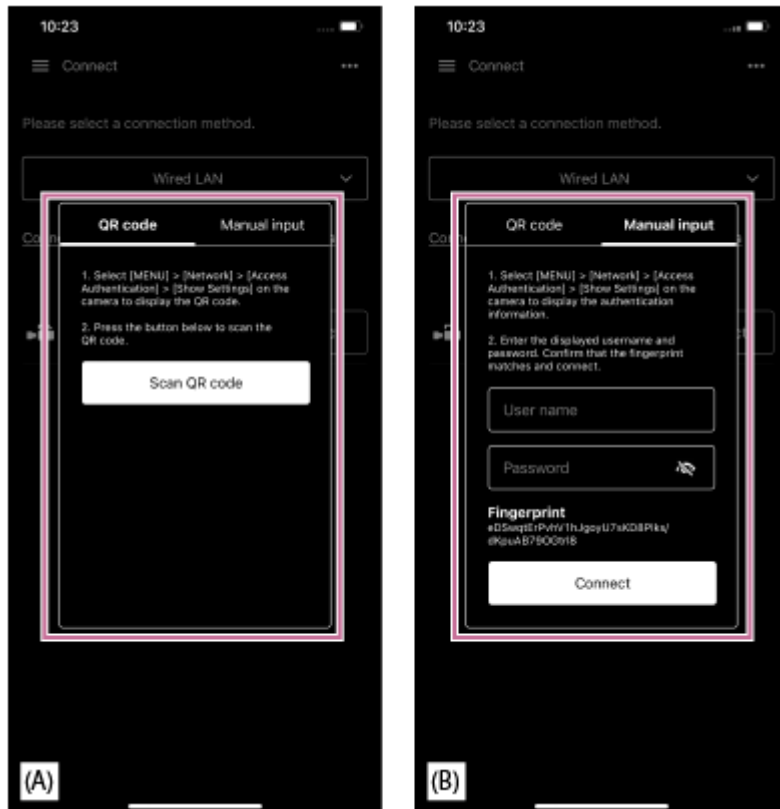

(A) Access authentication screen using QR code

(B) Access authentication screen using user name and password

### 1 Perform access authentication using one of the following procedures.

#### Access authentication using a QR code (recommended)

1. Tap [QR code] on the access authentication screen.
2. Tap [Scan QR code].
3. Scan the QR code displayed on the camera menu screen using the camera of the mobile device.
  - ILME-FX6: [Network] – [Access Authentication] – [Show Settings] screen
  - MPC-2610: [Network] – [Network Setup] – [Show Authentication] screen

#### Access authentication using a user name and password

1. Tap [Manual input] on the access authentication screen.
2. Set the user name.
  - ILME-FX6: [Network] – [Access Authentication] – [User Name]
  - MPC-2610: [Network] – [Network Setup] – [User Name]
3. Automatically generate a new password.
  - ILME-FX6: [Network] – [Access Authentication] – [Generate Password]

- MPC-2610: [Network] – [Network Setup] – [Generate Password]
4. Select [Network] – [Access Authentication] – [Show Settings].
  5. Display the user name and password.
  6. Enter the user name and password for access authentication, and tap [Connect].  
Check that the fingerprint matches the fingerprint of the camera to connect.

## 2 Check the status of the connection with the camera.

### Hint

- This setting is only required when you connect for the first time. Subsequently, the app uses the cached user name and password for authentication, hence access authentication is no longer required.

---

### Related Topic

- [Connecting Using Wi-Fi to a Camera Configured as an Access Point \(Wi-Fi Direct connection\) \(ILME-FX6/MPC-2610\)](#)
- [Connecting Using Wi-Fi to a Mobile Device Configured as an Access Point \(Tethering/Internet Sharing\) \(ILME-FX6/MPC-2610\)](#)
- [Connecting Using Wi-Fi via Wireless LAN Router Configured as an Access Point \(ILME-FX6/MPC-2610\)](#)
- [Connecting by Wired LAN via a Router \(ILME-FX6/MPC-2610\)](#)
- [Connecting Using USB to a Mobile Device Configured as an Access Point \(Tethering\) \(ILME-FX6/MPC-2610\)](#)
- [Disconnecting a Camera](#)

TP1001125860

## Disconnecting a Camera

This topic describes how to disconnect a camera.

- 1 Tap  (Menu) – [Connect].
- 2 Tap [Disconnect] for the camera to disconnect.

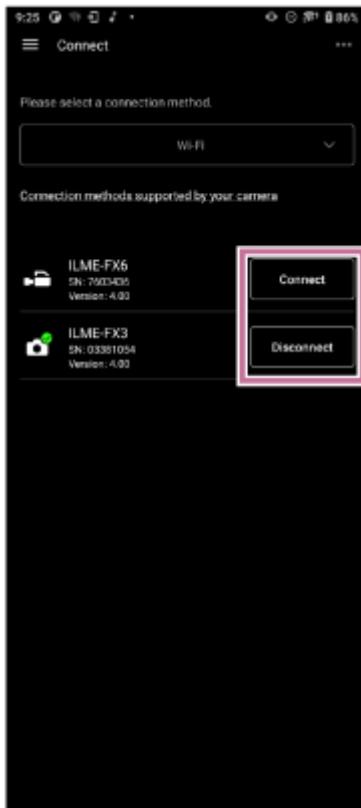

The camera is disconnected.

### Related Topic

- [Connecting Using Bluetooth Pairing \(Simple Connection\)](#)
- [Connecting Using Wi-Fi to a Camera Configured as an Access Point \(Wi-Fi Direct connection\) \(ILME-FX3/ILME-FX30/ILCE-9M3\)](#)
- [Connecting Using Wi-Fi to a Mobile Device Configured as an Access Point \(Tethering/Internet Sharing\) \(ILME-FX3/ILME-FX30/ILCE-9M3\)](#)
- [Connecting Using Wi-Fi via Wireless LAN Router Configured as an Access Point \(ILME-FX3/ILME-FX30/ILCE-9M3\)](#)
- [Authenticating Access When Connecting to a Camera \(ILME-FX3/ILME-FX30/ILCE-9M3\)](#)
- [Connecting Using Wi-Fi to a Camera Configured as an Access Point \(Wi-Fi Direct connection\) \(ILME-FX6/MPC-2610\)](#)
- [Connecting Using Wi-Fi to a Mobile Device Configured as an Access Point \(Tethering/Internet Sharing\) \(ILME-FX6/MPC-2610\)](#)
- [Connecting Using Wi-Fi via Wireless LAN Router Configured as an Access Point \(ILME-FX6/MPC-2610\)](#)
- [Connecting by Wired LAN via a Router \(ILME-FX6/MPC-2610\)](#)





- [Connecting Using USB to a Mobile Device Configured as an Access Point \(Tethering\) \(ILME-FX6/MPC-2610\)](#)

TP1001125861

H-479-100-12(1) Copyright 2023 Sony Corporation

## Deleting Access Authentication Credentials from the App

You can delete access authentication credentials (user name and password) saved in the app for all cameras at the same time.

- 1 Tap  (Menu) – [Connect].
- 2 Tap  (Others).
- 3 Select [Clear credentials] from the menu.

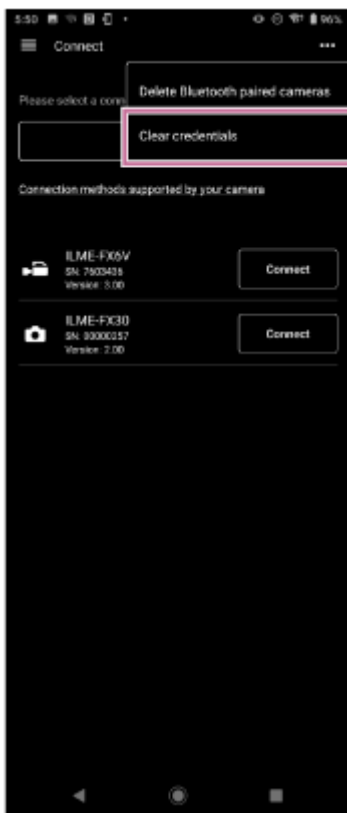

A deletion confirmation screen appears.

### Note

- Access authentication credentials cannot be deleted for cameras individually.

- 4 Tap [OK].

The access authentication credentials for all cameras are deleted.



### Related Topic

- [Authenticating Access When Connecting to a Camera \(ILME-FX3/ILME-FX30/ILCE-9M3\)](#)



## Bluetooth Unpairing

You can unpair Bluetooth paired cameras one at a time or all Bluetooth paired cameras at the same time.

- 1 Tap  (Menu) – [Connect].
- 2 Tap  (Others).
- 3 Select [Delete Bluetooth paired cameras] from the menu.

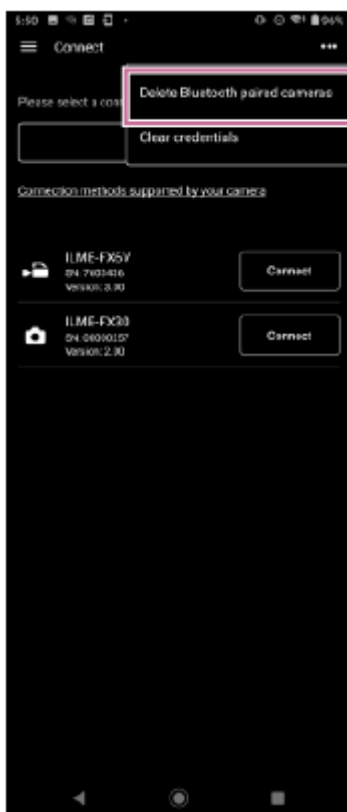

The list of paired cameras appears.

- 4 Select the camera to unpair.
  - To unpair all cameras, select [Select all] from the menu.

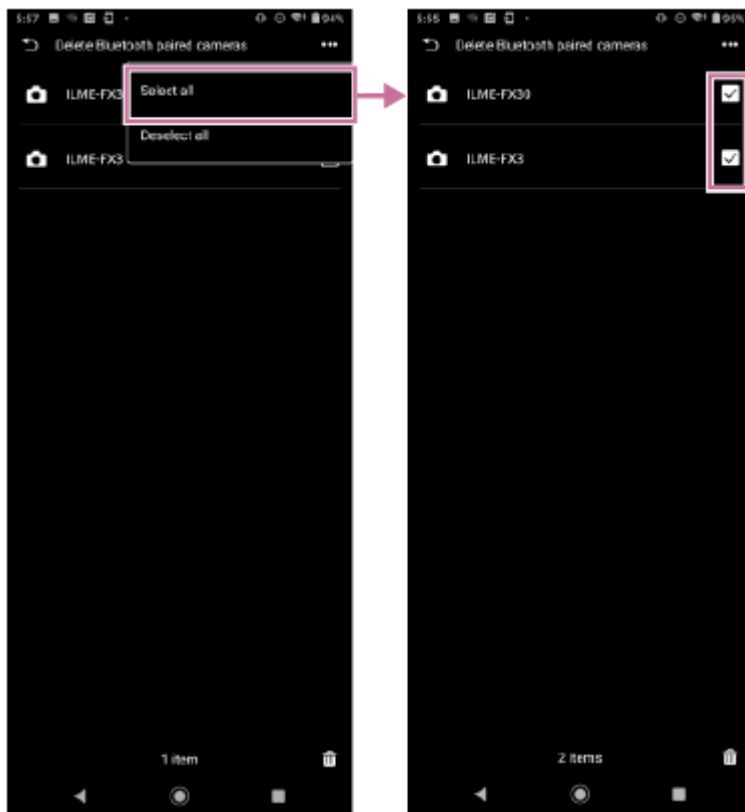

- To unpair specific cameras, place a check mark in the checkbox for the cameras you want to unpair.

The number of cameras to be unpaired is displayed at the bottom of the screen.

**5 Tap  (delete) at the bottom of the screen.**

The camera is unpaired and an unpairing completion message appears.

**6 Use the following procedure on the mobile device to cancel Bluetooth pairing.**

**On Android:**

1. Select [Settings] – [Device connection].
2. Select the gear icon for the corresponding device under [PREVIOUSLY CONNECTED DEVICES] and unpair the device.

**On iOS/iPadOS:**

1. Select [Settings] – [Bluetooth].
2. Select the “i” icon for the corresponding device under [MY DEVICES] and unpair the device.



**Related Topic**

- [Connecting Using Bluetooth Pairing \(Simple Connection\)](#)

TP1001125863

## Shooting

You can start shooting with a camera by remote control.





- 1 Tap  (Menu) – [Monitoring].  
The [Monitoring] screen appears.
- 2 Tap the mode selection area and select [Basic control].
- 3 Tap  (Start recording).



Shooting starts, and  (Start recording) changes to  (Stop recording).

- While shooting, a red frame is displayed around the image.



- To stop shooting, tap  (Stop recording).  (Stop recording) changes to  (Start recording).
- You can slide the  (Hold) switch to the right to lock the recording state (shooting or stopped) to prevent misoperation.



Slide the  (Hold) switch to the left to unlock the recording state.



### Hint

- The app screen can be displayed in either a vertical layout or horizontal layout, according to the mobile device settings. The display items and operation method are identical.

---

### Related Topic

- [Playing a Clip using the \[Monitoring\] Screen](#)
- [Checking a Proxy Clip/Original Clip](#)

TP1001125864

H-479-100-12(1) Copyright 2023 Sony Corporation

## Playing a Clip using the [Monitoring] Screen

You can play a clip on the media in a camera by remote control.

**1** Tap  (Menu) – [Monitoring].

The [Monitoring] screen appears.

**2** Tap the mode selection area and select [Playback].

**Note**

- [Playback] may not be selectable, depending on the camera.

**3** Play a clip.



(Play/Pause): Play/pause a clip.



(Fast rewind): Fast rewind a clip.



(Fast forward): Fast forward a clip.



(Stop): Stop clip playback.



(Previous): Jump to previous clip.



(Next): Jump to next clip.



(Recording review): Play last recorded clip.

### Related Topic

- [Shooting](#)

TP1001125865



Monitor & Control

## Displaying and Changing Camera Settings using the App

---

You can display and change the settings of a connected camera by remote control.

The settings that you can display/change vary depending on the connected camera. See “Connection Methods and Supported Functions.”

---

---

### Related Topic

- [Connection Methods and Supported Functions](#)

TP1001125866

## Basic Operation

This topic describes the basic operation for configuring camera settings.

### 1 Tap (Menu) – [Monitoring].

The [Monitoring] screen appears.

#### Hint

- You can change the resolution of the monitoring screen and select whether to give priority to resolution or drawing speed. Select [OTHER SETTINGS] – [Live view quality] to make changes.

### 2 Tap the mode selection area and select the screen to display.

The following describes the screen when [Basic control] is selected.



The [Basic control] screen appears.

### 3 Select the setting to display/change.

For details about camera functions that can be displayed or changed, see “Supported Cameras/Supported Functions.”

### 4 Check the displayed settings.

### 5 Change settings using the buttons/control bars as required.

When white balance is selected



- The configurable items will depend on the connected camera. For details, see the Help Guide or operating instructions for the camera.

## Common functions on the [Monitoring] screen

### Shooting assist functions

You can tap [TOOL] and enable/disable four shooting assist functions: [Waveform], [Histogram], [False color], and [Zebra]. You can also change settings depending on the function. Note that [Waveform] and [Histogram] cannot be enabled at the same time. Note that [False color] and [Zebra] cannot be enabled at the same time.

▣ (Scale from top right) / ▣ (Scale from bottom right): Drag to resize window.

☰ (Move): Drag to move window.



- [Waveform]



- [Histogram]



- [False color]
  - 🔧 (Settings): You can select the color distribution pattern from the color palette.
    - [Pattern1 (SDR)]: Color distribution pattern suitable for SDR shooting
    - [Pattern2 (S-Log3)]: Color distribution pattern suitable for S-Log3 shooting

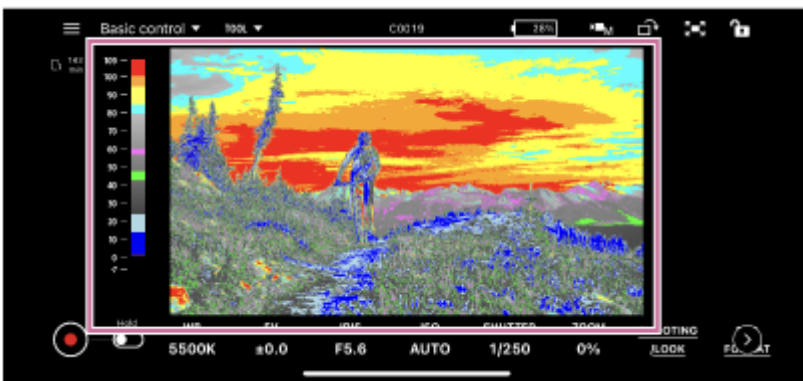

- [Zebra]
  - 🔧 (Settings): You can set the threshold value.



### Screen area resize

You can adjust the screen area size using  (Increase screen area) and  (Decrease screen area).

### Screen control lock

 (Lock): Lock screen control to prevent inadvertent operation.

 (Unlock): Unlock screen control to enable operation.

### Live view rotation

 (Live view rotation): Rotate the live view (image display area) clockwise. Rotate by 90° with each tap.

### Note

- If you start recording with the live view in a rotated orientation, the image is still recorded in normal orientation (without rotation).
- On Android, this function may not be available depending on the connected camera.

 (Exposure mode select): Allows you to switch to any exposure mode.

## Note

-  (Exposure mode select) is displayed only when the camera is an ILME-FX3/ILME-FX30/ILCE-9M3.

---

## Related Topic

- [Connection Methods and Supported Functions](#)
- [White Balance](#)
- [Exposure](#)
- [Gain](#)
- [ISO](#)
- [Exposure Index](#)
- [Shutter Speed](#)
- [Zoom](#)
- [ND Filter](#)
- [Iris](#)
- [Focus](#)
- [Iris/ND Filter](#)
- [Assignable Buttons](#)
- [Shooting Mode, Look, and Recording Format Settings](#)
- [Other Settings](#)

TP1001125867

## White Balance

This topic describes how to set the white balance.

- 1 Tap  (Menu) – [Monitoring].  
The [Monitoring] screen appears.
- 2 Tap the mode selection area and select [Basic control].  
The [Basic control] screen appears.
- 3 Check the white balance set value displayed in [WB].



- 4 To change the white balance, tap [WB].  
The white balance becomes editable.



- 5 Change the white balance.
  - The configurable items will depend on the connected camera. For details, see the Help Guide or operating instructions for the camera.

### Related Topic

- [Displaying and Changing Camera Settings using the App](#)



## Exposure

This topic describes how to set the exposure.

- You can set the exposure only if the connected camera is an ILME-FX3/ILME-FX30/ILCE-9M3.

**1 Tap  (Menu) – [Monitoring].**

The [Monitoring] screen appears.

**2 Tap the mode selection area and select [Basic control].**

The [Basic control] screen appears.

**3 Check the exposure correction displayed in [EV].**



**4 To change the exposure correction, tap [EV].**

The exposure correction becomes editable.



**5 Change the exposure correction.**

- The configurable items will depend on the connected camera. For details, see the Help Guide or operating instructions for the camera.



---

---

## Related Topic

- [Displaying and Changing Camera Settings using the App](#)

TP1001125869

H-479-100-12(1) Copyright 2023 Sony Corporation

## Gain

---

This topic describes how to set the gain.

- You can set the gain when the connected camera is an ILME-FX6/MPC-2610 and the sensitivity is set to gain.

**1** Tap  (Menu) – [Monitoring].

The [Monitoring] screen appears.

**2** Tap the mode selection area and select [Basic control].

The [Basic control] screen appears.

**3** Check the gain value displayed in [GAIN].

**4** To change the gain, tap [GAIN].

The gain becomes editable.

**5** Change the gain.

- The configurable items will depend on the connected camera. For details, see the Help Guide or operating instructions for the camera.

---

### Related Topic

- [Displaying and Changing Camera Settings using the App](#)

TP1001125870

## ISO

This topic describes how to set the ISO.

- Configurable when the sensitivity is set using the ISO on the camera.

**1** Tap  (Menu) – [Monitoring].

The [Monitoring] screen appears.

**2** Tap the mode selection area and select [Basic control].

The [Basic control] screen appears.

**3** Check the ISO sensitivity displayed in [ISO].



**4** To change the ISO, tap [ISO].

The ISO becomes editable.



**5** Change the ISO.

- The configurable items will depend on the connected camera. For details, see the Help Guide or operating instructions for the camera.

---

---

## Related Topic

- [Displaying and Changing Camera Settings using the App](#)

TP1001125871

H-479-100-12(1) Copyright 2023 Sony Corporation

## Exposure Index

This topic describes how to set the exposure index.

- Configurable when the sensitivity is set using the exposure index on the camera.

**1 Tap  (Menu) – [Monitoring].**

The [Monitoring] screen appears.

**2 Tap the mode selection area and select [Basic control].**

The [Basic control] screen appears.

**3 Check the exposure index displayed in [EI].**



**4 To change the exposure index, tap [EI].**

The exposure index becomes editable.



**5 Change the exposure index.**

- The configurable items will depend on the connected camera. For details, see the Help Guide or operating instructions for the camera.

---

---

## Related Topic

- [Displaying and Changing Camera Settings using the App](#)

TP1001125872

H-479-100-12(1) Copyright 2023 Sony Corporation

## Monitor &amp; Control

## Shutter Speed

This topic describes how to set the shutter speed.

- 1 Tap  (Menu) – [Monitoring].  
The [Monitoring] screen appears.
- 2 Tap the mode selection area and select [Basic control].  
The [Basic control] screen appears.
- 3 Check the shutter speed displayed in [SHUTTER].



- 4 To change the shutter speed, tap [SHUTTER].  
The shutter speed becomes editable.



- 5 Change the shutter speed.

- The configurable items will depend on the connected camera. For details, see the Help Guide or operating instructions for the camera.

### Related Topic

- [Displaying and Changing Camera Settings using the App](#)





## Image Stabilization

---

This topic describes the image stabilization function.

**1 Tap  (Menu) – [Monitoring].**

The [Monitoring] screen appears.

**2 Tap the mode selection area and select [Basic control].**

The [Basic control] screen appears.

**3 Check the image stabilization value for zoom displayed in [IS] (Image Stabilization).**

**4 To change the image stabilization set value, tap [IS].**

The image stabilization set value becomes editable.

**5 Change the image stabilization set value.**

- The configurable items will depend on the connected camera. For details, see the Help Guide or operating instructions for the camera.

---

### Related Topic

- [Displaying and Changing Camera Settings using the App](#)

TP1001426004

## Zoom

This topic describes how to set the zoom.

- 1 Tap  (Menu) – [Monitoring].  
The [Monitoring] screen appears.
- 2 Tap the mode selection area and select [Basic control].  
The [Basic control] screen appears.
- 3 Check the zoom set value displayed in [ZOOM].



- 4 To change the zoom set value, tap [ZOOM].  
The zoom set value becomes editable.



- 5 Change the zoom setting.
  - The configurable items will depend on the connected camera. For details, see the Help Guide or operating instructions for the camera.

### Related Topic

- [Displaying and Changing Camera Settings using the App](#)



## ND Filter

---

This topic describes how to set the ND filter.

- You can set the ND filter only if the connected camera is an ILME-FX6/MPC-2610.

**1** Tap  (Menu) – [Monitoring].

The [Monitoring] screen appears.

**2** Tap the mode selection area and select [Basic control].

The [Basic control] screen appears.

**3** Check the ND filter setting displayed in [ND].

**4** To change the ND filter setting, tap [ND].

In [Variable] mode, the ND filter setting becomes editable.

**5** Change the ND filter setting.

- The configurable items will depend on the connected camera. For details, see the Help Guide or operating instructions for the camera.

---

### Related Topic

- [Displaying and Changing Camera Settings using the App](#)

TP1001125875

## Monitor &amp; Control

## Iris

This topic describes how to set the iris.

- 1 Tap  (Menu) – [Monitoring].  
The [Monitoring] screen appears.
- 2 Tap the mode selection area and select [Basic control].  
The [Basic control] screen appears.
- 3 Check the iris setting displayed in [IRIS].



- 4 To change the iris setting, tap [IRIS].  
The iris setting becomes editable.



- 5 Change the iris setting.
  - The configurable items will depend on the connected camera. For details, see the Help Guide or operating instructions for the camera.

## Related Topic

- [Displaying and Changing Camera Settings using the App](#)



## Focus

This topic describes how to set the focus.

- 1 Tap  (Menu) – [Monitoring].  
The [Monitoring] screen appears.
- 2 Tap the mode selection area and select [Focus control].  
The [Focus control] screen appears.
- 3 Tap the [FOCUS] tab.  
The focus setting screen appears.



- 4 Check the focus setting and adjust the focus as required.

- The configurable items will depend on the connected camera. For details, see the Help Guide or operating instructions for the camera.
- The selection options will vary depending on your camera.



### [AF]/[MF]

Indicates the current focus operating state.

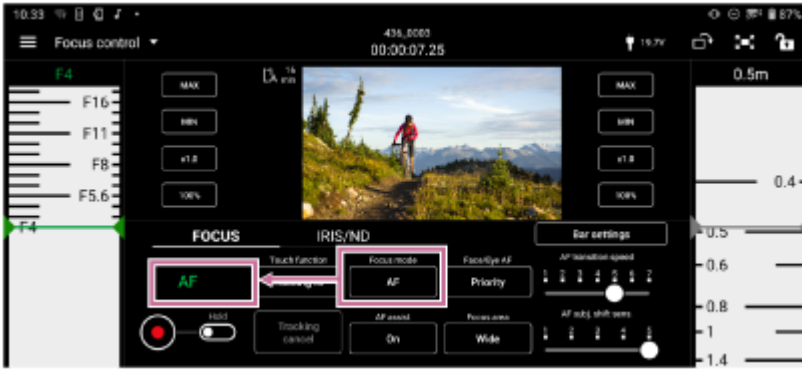

You can adjust the focus using the following buttons and control bars.



#### [Focus mode]

Select [AF] or [MF] focus mode.

#### [Touch function]

- [Tracking AF]: Tap the camera image to specify the focus target for tracking.
- [Spot focus]: When [Focus mode] is set to [MF], tap the camera image to specify the position for which to adjust the focus.
- [Focus area]: When [Focus area] is set to [Zone] or [Spot], tap the camera image to specify the position to which to move the displayed focus area frame.
- [Off]: Disable touch operation on the camera image.

#### [Face/Eye AF] or [Subj. recog. AF]

Select [Only], [Priority], or [Off].

#### Hint

- Select [Face/Eye AF] or [Subj. recog. AF], depending on your camera.

#### [AF assist]

Select [On] or [Off].

#### [Focus area]

Select [Wide], [Zone], [Center], [Spot], or [Custom].

#### [Tracking cancel]

Tap to cancel tracking.

#### [AF transition speed]

Select a number in the range [1] to [7].

#### [AF subj. shift sens.]

Select a number in the range [1] to [5].

- **Control bars**

Scroll the left/right control bars to adjust the focus.





### [Bar settings]

- [Left bar]/[Right bar]: Select the setup items ([FOCUS], [IRIS], [IRIS (Relative)], or [None]) to display on the left/right control bars. Place a check mark in [Reverse] to switch the ascending/descending orientation of the scale on the control bars. By default, only the right control bar is displayed.
- [Focus distance display]: Sets the display units.
- [Detection/Tracking frame color]: Set the face/eye detection frame and tracking frame colors.

### [Max], [Min]

Set the current set value to the upper limit or lower limit. Scrolling the control bar beyond the limits becomes disabled.

### [x0.1] to [x1.5]

Select the scrolling speed of the control bars.

### [50%] to [350%]

Select the display magnification of the control bars.

### Hint

- For lenses that do not support manual focus operation by specifying a distance, the focus control bar is displayed in %. For such lenses, see “Lenses that Do Not Support Manual Focus Operation by Specifying a Distance.”

### Focus area frames

The following frames may be displayed on the camera image according to the focus setting.

- : Focus area frame (normal operation)
- : Focus area frame (movable)
- : Face/eye detection frame
- : Tracking frame

### Related Topic

- [Displaying and Changing Camera Settings using the App](#)
- [Lenses that Do Not Support Manual Focus Operation by Specifying a Distance](#)

TP1001125877

## Iris/ND Filter

This topic describes how to set the iris/ND filter.

- Can only be displayed if the connected camera is an ILME-FX6/MPC-2610.

**1** Set the iris ring of the camera lens to the “A” position.

**2** Tap  (Menu) – [Monitoring].

The [Monitoring] screen appears.

**3** Tap the mode selection area and select [Focus control].

The [Focus control] screen appears.

**4** Tap the [IRIS/ND] tab.

The iris/ND filter setup screen appears.



**5** Check the iris/ND filter setting and adjust the focus as required.

- The configurable items will depend on the connected camera. For details, see the Help Guide or operating instructions for the camera.

Tap [IRIS] –  (Left step) or  (Right step) to select an F value.



[Touch function]

- [Tracking AF]: Tap the camera image to specify the focus target for tracking.
- [Spot focus]: When [Focus mode] is set to [MF], tap the camera image to specify the position for which to adjust the focus.
- [Focus area]: When [Focus area] is set to [Zone] or [Spot], tap the camera image to specify the position to which to move the displayed focus area frame.
- [Off]: Disable touch operation on the camera image.

### [Auto IRIS]

Select [On] or [Off].

### [ND mode]

Select [Variable], [Preset], or [Step]. When [Variable], [Preset], or [Step] is selected, the position of the ND filter cannot be selected.

### Hint

- Select [Variable], [Preset], or [Step], depending on your camera.

### [Auto ND]

Select [On] or [Off]. Selectable when [ND mode] is set to [Variable].

### [ND]

Select a value in the range [1/128] to [1/4] or [Clear]. Selectable when [ND mode] is set to [Variable].

### ● Control bars

Scroll the left/right control bars to adjust the iris.

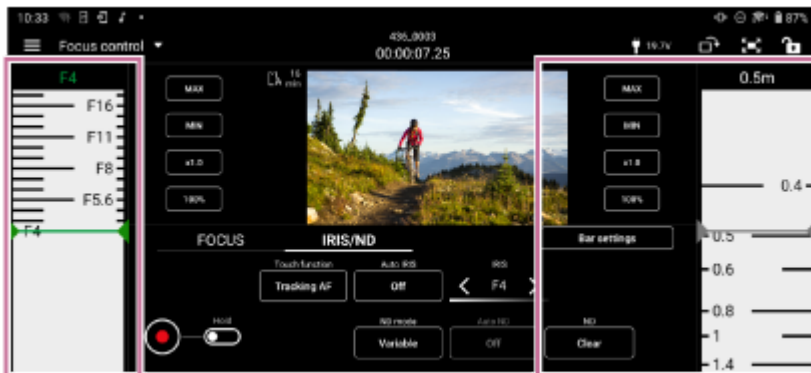

### [Bar settings]

- [Left bar]/[Right bar]: Select the setup items ([FOCUS], [IRIS], [IRIS (Relative)], or [None]) to display on the left/right control bars. Place a check mark in [Reverse] to switch the ascending/descending orientation of the scale on the control bars. By default, only the right control bar is displayed.
- [Focus distance display]: Sets the display units.
- [Detection/Tracking frame color]: Set the face/eye detection frame and tracking frame colors.

### [Max], [Min]

Set the current set value to the upper limit or lower limit. Scrolling the control bar beyond the limits becomes disabled.

### [x0.1] to [x1.5]

Select the scrolling speed of the control bars.

### [50%] to [350%]

Select the display magnification of the control bars.

## Related Topic

- [Displaying and Changing Camera Settings using the App](#)



## Assignable Buttons

---

You can check and execute the functions assigned to the assignable buttons of a camera by remote control. Changing function assignments and other operations must be performed on the camera itself. For details, see the Help Guide or operating instructions for the camera.

- 1 Tap  (Menu) – [Monitoring].**  
The [Monitoring] screen appears.
- 2 Tap the mode selection area and select [Assign].**  
The [Assign] screen appears.
- 3 Tap an assignable button assigned with a function.**  
The selected function is executed.

### Note

- This function may not be available, depending on the camera.

TP1001125879

## Shooting Mode, Look, and Recording Format Settings

This topic describes the settings related to the shooting mode, look, and recording format. The functions that can be checked/configured and their basic operation are described below.

### ILME-FX3/ILME-FX30/ILCE-9M3

App function name		Camera function name (menu name)
[SHOOTING/LOOK]	[Log shooting]	[Log Shooting]
	[Color gamut]	[Color Gamut]
	[Select LUT]	[Select LUT]
	[Picture profile]	[Picture Profile]
	[Display LUT]	[Display LUT]
[REC FORMAT]	[Video format]	[File Format]
	[Frame rate]	[Rec Frame Rate]
	[Resolution]	[Record Setting]

### ILME-FX6/MPC-2610

App function name		Camera function name (menu name)
[SHOOTING/LOOK]	[Shooting mode]	[Shooting Mode]
	[Scene file]	[Scene File]
	[Color gamut]	[Color Gamut]
	[Base look]	[Base Look]
[REC FORMAT]	[Video format]	[Codec] <sup>*1</sup>
	[Frame rate]	[Frequency] <sup>*1</sup>
	[Resolution]	[Video Format]

\*1 Can only be checked

- 1** Tap  (Menu) – [Monitoring].

The [Monitoring] screen appears.
- 2** Tap the mode selection area and select [Basic control].

The [Basic control] screen appears.
- 3** To set the shooting mode/look, tap [SHOOTING/LOOK]. To set the recording format, tap [REC FORMAT].

The configurable items appear.

4 Check the setting and change the setting as required.



- Tap (Submenu view) on the right side of the item to display the setup screen at the next level in the hierarchy.

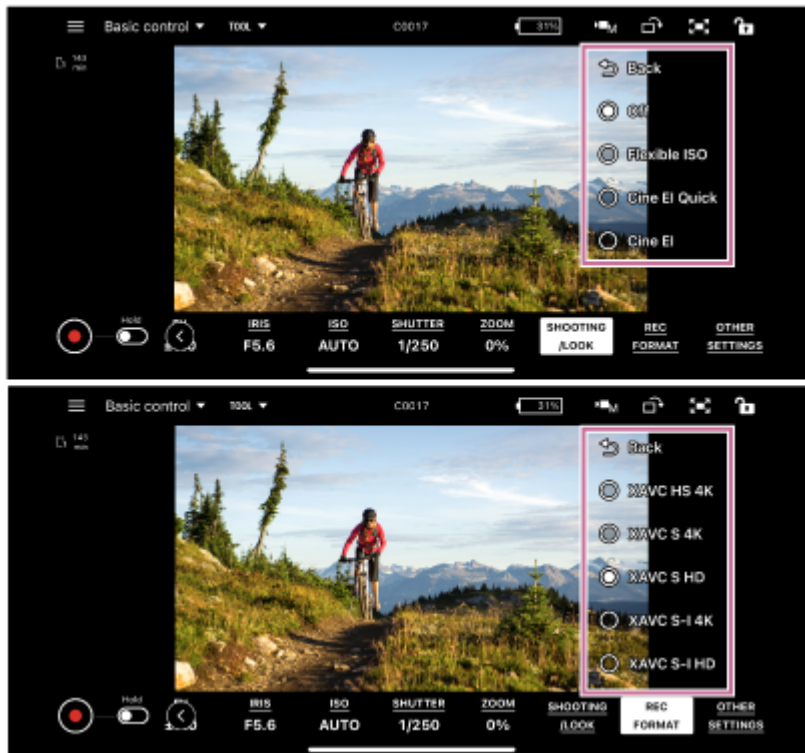

- The configurable items will depend on the connected camera. For details, see the Help Guide or operating instructions for the camera.





## Importing a LUT

You can import a LUT file (.cube) saved in mobile device storage into a camera.

This is configurable only if the connected camera is an ILME-FX3/ILME-FX30/ILCE-9M3.

**This function cannot be used if [Log shooting] is set to [Off].**

- 1 Tap  (Menu) – [Monitoring].  
The [Monitoring] screen appears.
- 2 Tap the mode selection area and select [Basic control].  
The [Basic control] screen appears.
- 3 Tap [SHOOTING/LOOK].  
The configurable items appear.
- 4 Tap [Select LUT].
- 5 Tap the gear icon displayed beside the LUT to register.



- 6 Tap [Import].  
A file selection screen corresponding to the mobile device OS appears.

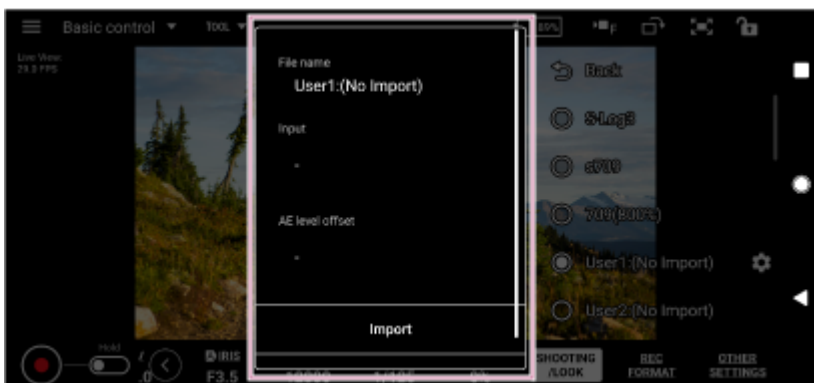

- 7 Select a LUT file to import.

**8 Edit [Color gamut] and [AE level offset], as required.**

TP1001426005

H-479-100-12(1) Copyright 2023 Sony Corporation

## Other Settings

You can check/set other functions indicated below.

- You can set the following functions only if the connected camera is an ILME-FX3/ILME-FX30/ILCE-9M3.

App function name		Camera function name (menu name)
[OTHER SETTINGS]	[Live view quality]	–
	[Mode dial operation]*	–
	[Exposure control type]	[Exposure Ctrl Type]
	[D-Range optimizer]	[D-Range Optimizer]
	[Metering mode]	[Metering Mode]
	[AE lock]	[AE lock]
	[Zoom setting]	[Zoom Range]
	[Variable shutter]	[Anti-flicker Shoot.]

\* Displayed only for the ILCE-9M3.

- 1 Tap  (Menu) – [Monitoring].

The [Monitoring] screen appears.

- 2 Tap the mode selection area and select [Basic control].

The [Basic control] screen appears.

- 3 Tap [OTHER SETTINGS].



The configurable items appear.

- 4 Check the setting and change the setting as required.



- Tap ► (Submenu view) on the right side of the item to display the setup screen at the next level in the hierarchy.



- The configurable items will depend on the connected camera. For details, see the Help Guide or operating instructions for the camera.

## Related Topic

- [Displaying and Changing Camera Settings using the App](#)

TP1001125881

## Checking a Proxy Clip/Original Clip

This topic describes how to check a proxy clip/original clip.

**1 Tap  (Menu) – [Browse].**

The [Browse] screen appears.

**2 Select the type of clip.**

Tap the [Proxy] tab for proxy clips. Tap the [Original] tab for original clips. Tap the [Local] tab for proxy clips imported into a mobile device.

**3 If [Slot A] and [Slot B] are displayed, select a slot.**

This step is not required to play a proxy clip imported into a mobile device.

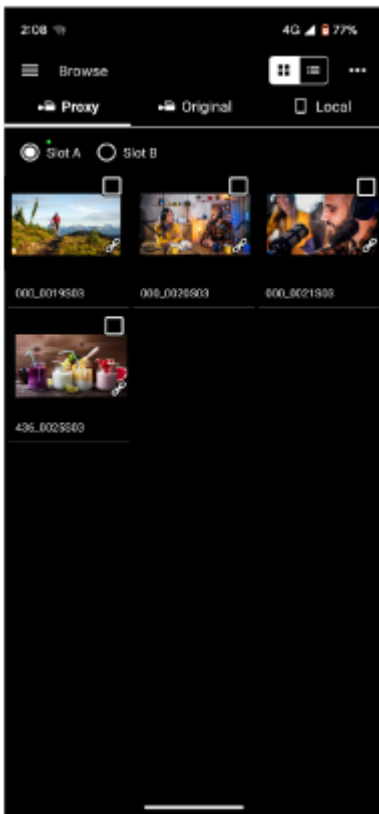

The proxy clips or original clips on the camera are displayed.

**4 Select a clip.**

Tap the checkbox for the selected clip to place a check mark in the checkbox. Tap outside the checkbox to switch to the player screen. Playback starts automatically from the start of the clip.

- For details about playback, see “Playing a Clip using the Player Screen.”

---

## Related Topic

- [Displaying a Clip Imported into a Mobile Device](#)
- [Switching the Clip Display View](#)
- [Renaming a Clip](#)
- [Deleting a Clip](#)
- [Importing a Proxy Clip using the \[Browse\] Screen](#)
- [Transferring a Clip to an FTP Server using the \[Browse\] Screen](#)
- [Sharing a Clip Imported into a Mobile Device](#)
- [Playing a Clip using the Player Screen](#)
- [Importing a Proxy Clip using the Player Screen](#)
- [Transferring a Clip to an FTP Server using the Player Screen](#)
- [Transferring Part of a Clip to an FTP Server](#)
- [Checking Clip Properties](#)

TP1001125882

## Monitor &amp; Control

## Displaying a Clip Imported into a Mobile Device

You can display and play clips imported into a mobile device. You can also check clip properties, delete files, and share with other applications, such as video applications.

**1** Tap  (Menu) – [Browse].

The [Browse] screen appears.

**2** Tap the [Local] tab.

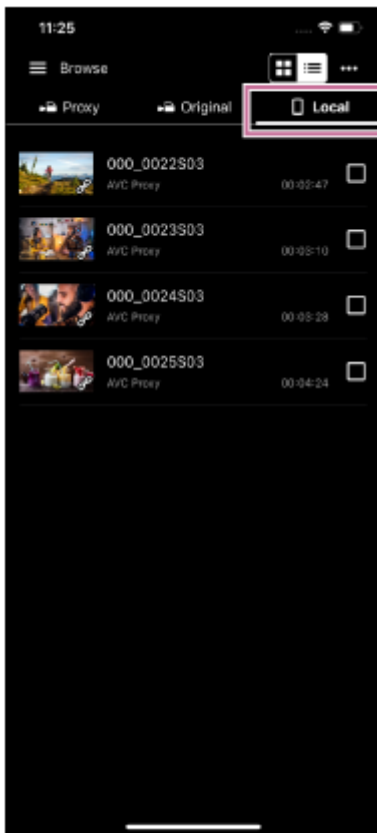

The clips imported into the mobile device are displayed.

### Note

- Sharing with other applications is available only on Android devices.

### Related Topic

- [Playing a Clip using the \[Monitoring\] Screen](#)
- [Switching the Clip Display View](#)
- [Renaming a Clip](#)
- [Deleting a Clip](#)
- [Importing a Proxy Clip using the \[Browse\] Screen](#)

- [Sharing a Clip Imported into a Mobile Device](#)
- [Playing a Clip using the Player Screen](#)
- [Importing a Proxy Clip using the Player Screen](#)
- [Checking Clip Properties](#)



TP1001125883

H-479-100-12(1) Copyright 2023 Sony Corporation



## Switching the Clip Display View

You can switch the clip display between grid view and list view.

- 1 Tap  (Menu) – [Browse].
- 2 Tap  (Grid view) or  (List view) to switch the display.

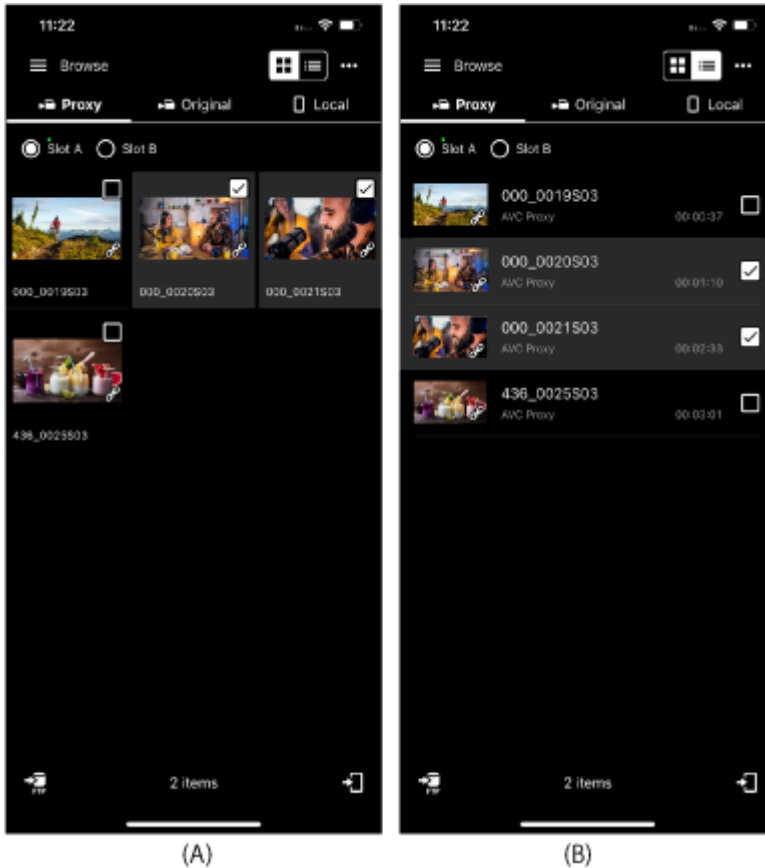

(A) Grid view

(B) List view

### Related Topic

- [Checking a Proxy Clip/Original Clip](#)
- [Renaming a Clip](#)
- [Deleting a Clip](#)
- [Checking Clip Properties](#)

## Renaming a Clip

You can rename a clip imported into a mobile device.

1 Tap  (Menu) – [Browse].

2 Tap the [Local] tab.

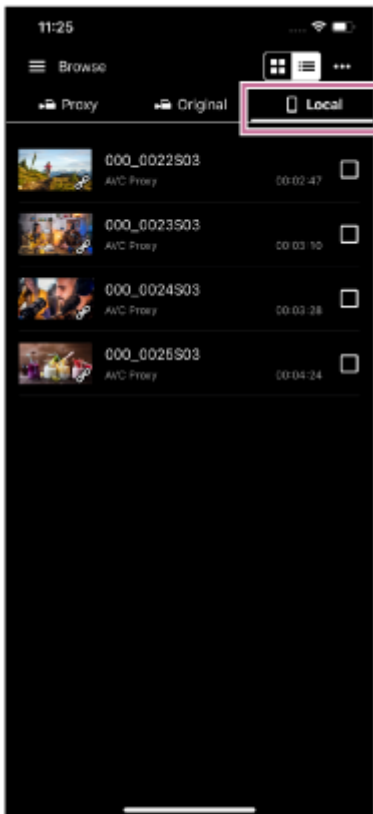

The clips imported into the mobile device are displayed.

3 Place a check mark in the checkbox of the clip to rename.

4 Tap  (Rename).

A confirmation screen appears.

5 Enter a new name and tap [OK].

### Note

- This function is supported on Android mobile devices only.

- [Displaying a Clip Imported into a Mobile Device](#)
- [Deleting a Clip](#)
- [Importing a Proxy Clip using the \[Browse\] Screen](#)
- [Importing a Proxy Clip using the Player Screen](#)
- [Checking Clip Properties](#)

TP1001125885

H-479-100-12(1) Copyright 2023 Sony Corporation

## Deleting a Clip

You can delete a clip imported into a mobile device.

1 Tap  (Menu) – [Browse].

2 Tap the [Local] tab.

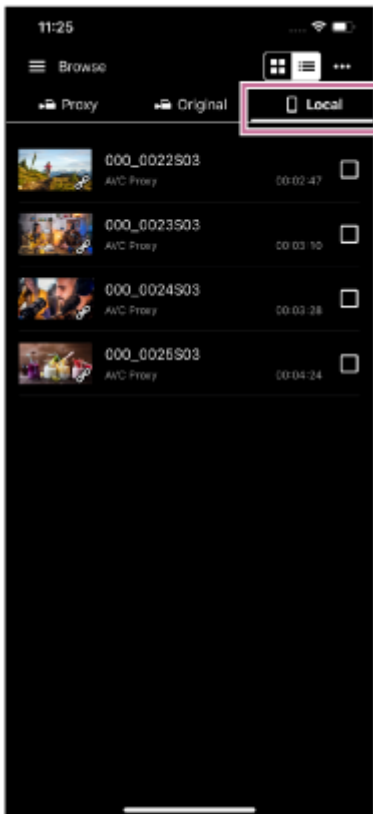

3 Place a check mark in the checkbox of the clip to delete.

4 Tap  (Delete).

A confirmation screen appears.

5 Tap [OK].



### Related Topic

- [Displaying a Clip Imported into a Mobile Device](#)
- [Renaming a Clip](#)
- [Importing a Proxy Clip using the \[Browse\] Screen](#)
- [Importing a Proxy Clip using the Player Screen](#)
- [Checking Clip Properties](#)



## Importing a Proxy Clip using the [Browse] Screen

You can import a proxy clip from a camera into a mobile device using the [Browse] screen.

- 1 Tap  (Menu) – [Browse].
- 2 Tap the [Proxy] tab.
- 3 If [Slot A] and [Slot B] are displayed, select a slot.
- 4 Place a check mark in the checkbox of the clip to import.
- 5 Tap  (Import).

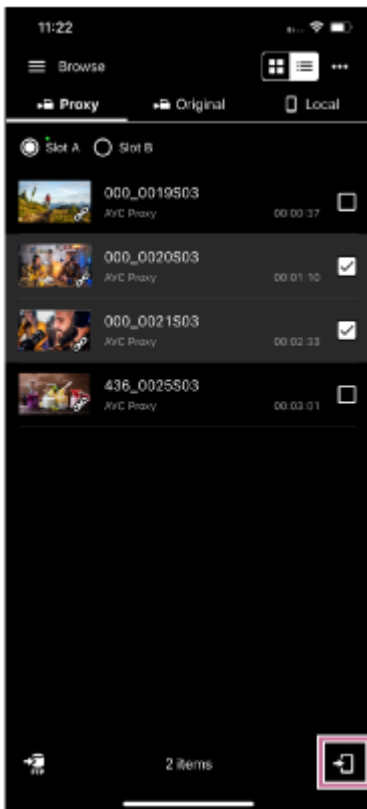

The proxy clip is imported into the mobile device.

- You can check the import result and status in the job list. For details about the job list, see “Checking the Job List.”

### Hint

- You can import a proxy clip from a camera using the player screen. See “Importing a Proxy Clip using the Player Screen.”
- On the ILME-FX3/ILME-FX30/ILCE-9M3, import using Creators' App.

---

## Related Topic

- [Checking a Proxy Clip/Original Clip](#)
- [Displaying a Clip Imported into a Mobile Device](#)
- [Transferring a Clip to an FTP Server using the \[Browse\] Screen](#)
- [Sharing a Clip Imported into a Mobile Device](#)
- [Playing a Clip using the Player Screen](#)
- [Importing a Proxy Clip using the Player Screen](#)
- [Transferring a Clip to an FTP Server using the Player Screen](#)
- [Transferring Part of a Clip to an FTP Server](#)
- [Checking Clip Properties](#)
- [Checking the Job List](#)

TP1001125887

H-479-100-12(1) Copyright 2023 Sony Corporation

## Transferring a Clip to an FTP Server using the [Browse] Screen

You can transfer a clip from a camera to an FTP server using the [Browse] screen.

- 1 Configure FTP transfer settings on the camera beforehand.**
  - For details about FTP transfer settings on a camera, see the Help Guide or operating instructions for the camera.
- 2 Tap  (Menu) – [Browse].**
- 3 Select the type of clip.**

Tap the [Proxy] tab for proxy clips. Tap the [Original] tab for original clips.
- 4 If [Slot A] and [Slot B] are displayed, select a slot.**
- 5 Place a check mark in the checkbox of the proxy clip to transfer to an FTP server.**
- 6 Tap  (Transfer).**

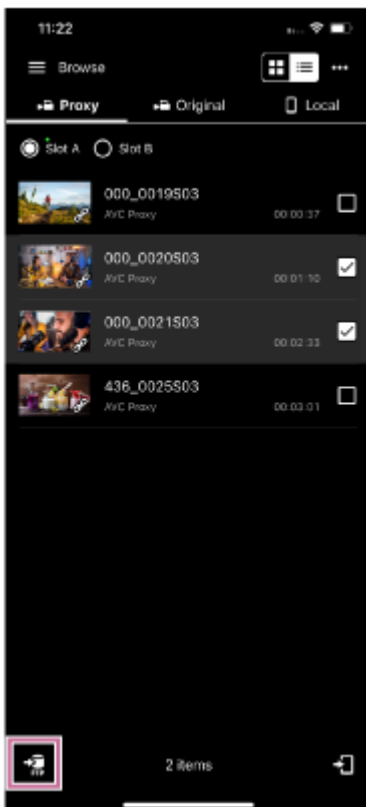

The FTP transfer setup screen appears.

- 7 Configure [Destination] and other transfer settings, then tap [OK].**

The clip is transferred to the FTP server.



- You can check the FTP server transfer result and status in the job list. For details about the job list, see “Checking the Job List.”

#### Hint

- You can transfer a clip from a camera to an FTP server using the player screen. See “Transferring a Clip to an FTP Server using the Player Screen.”
- You can also transfer a part of a clip to an FTP server using the player screen. See “Transferring Part of a Clip to an FTP Server.”

---

#### Related Topic

- [Transferring a Clip to an FTP Server using the Player Screen](#)
- [Transferring Part of a Clip to an FTP Server](#)
- [Checking the Job List](#)

TP1001125888



H-479-100-12(1) Copyright 2023 Sony Corporation

## Sharing a Clip Imported into a Mobile Device

---

You can share a clip imported into a mobile device with other applications, such as a video sharing service.

- This function is supported on Android mobile devices only.

- 1 Tap  (Menu) – [Browse].
- 2 Tap the [Local] tab.
- 3 Place a check mark in the checkbox of the clip to share.
- 4 Tap  (Share).  
A list of applications that can be used appears.
- 5 Tap the application to use.  
The application launches.
- 6 Follow the instructions on the application screen to share the clip.

---

### Related Topic

- [Importing a Proxy Clip using the \[Browse\] Screen](#)
- [Importing a Proxy Clip using the Player Screen](#)

TP1001125889

## Playing a Clip using the Player Screen

This topic describes clip operations.

1 Tap  (Menu) – [Browse].

2 Select the type of clip.

Tap the [Proxy] tab for proxy clips. Tap the [Local] tab for proxy clips imported into a mobile device.

### Hint

- When a proxy is recorded, you can play an original clip using the proxy.

3 If [Slot A] and [Slot B] are displayed, select the slot and then tap a clip.

Selecting the slot is not required to play a proxy clip imported into a mobile device.

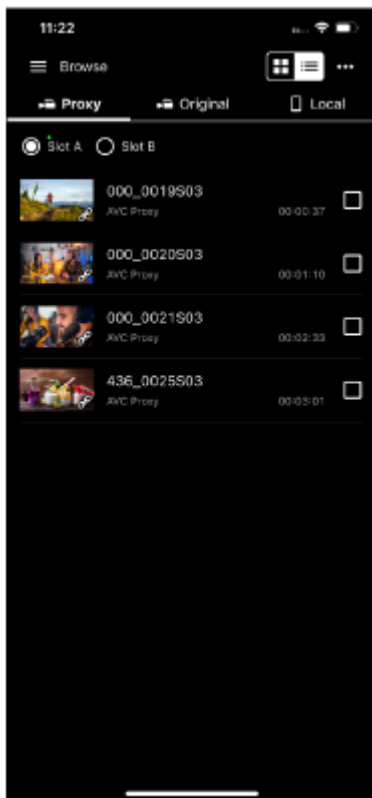

The player screen for the selected clip appears.

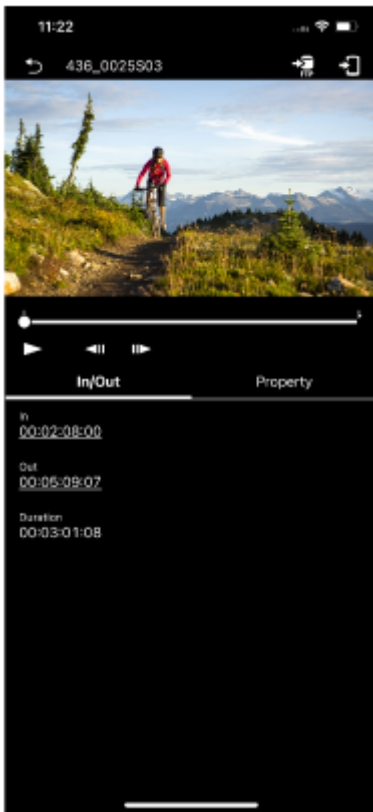

**4 Play the clip using the player screen.**

(Play): Play the clip.

(Stop): Stop clip playback.

(Frame rewind)/ (Frame advance): Tap (Frame rewind) or (Frame advance) to rewind/advance the image one frame at a time.

- **To set the video playback start position**

Drag (Seekbar knob) in the seekbar or tap the seekbar to view the image at a desired position.

- **To return to the clip list screen ([Browse] screen)**

Tap (Previous screen) to return to the clip list screen ([Browse] screen).

**Related Topic**

- [Checking a Proxy Clip/Original Clip](#)
- [Displaying a Clip Imported into a Mobile Device](#)

TP1001125890

## Importing a Proxy Clip using the Player Screen

You can import a proxy clip from a camera into a mobile device using the player screen.

- 1 Tap  (Menu) – [Browse].
- 2 Tap the [Proxy] tab.
- 3 If [Slot A] and [Slot B] are displayed, select the slot and then tap a clip to import.

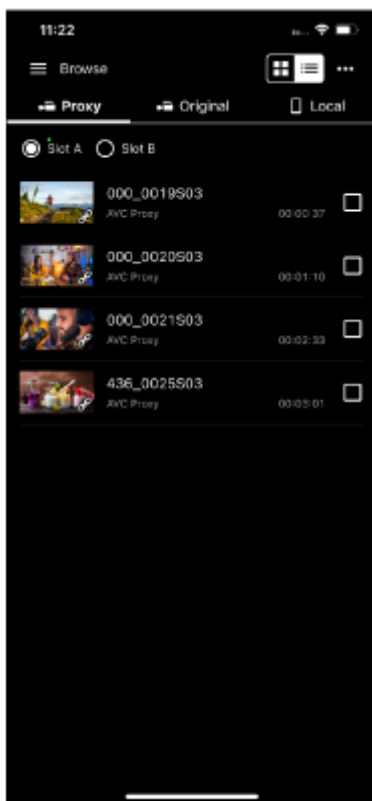

The player screen for the tapped proxy clip appears.

- 4 Tap  (Import).

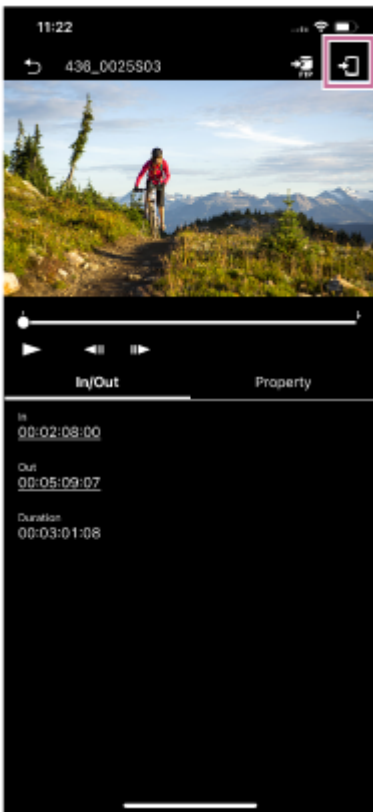

The proxy clip is imported into the mobile device.

- You can check the import result and status in the job list. For details about the job list, see “Checking the Job List.”

### Hint

- You can also import a proxy clip from a camera using the [Browse] screen. See “Importing a Proxy Clip using the [Browse] Screen.”
- On the ILME-FX3/ILME-FX30/ILCE-9M3, import using Creators' App.
- You can configure the action to take if a clip with the same name exists using  (Menu) – [Settings] – [Import clip].

### Related Topic

- [Checking a Proxy Clip/Original Clip](#)
- [Displaying a Clip Imported into a Mobile Device](#)
- [Importing a Proxy Clip using the \[Browse\] Screen](#)
- [Transferring a Clip to an FTP Server using the \[Browse\] Screen](#)
- [Sharing a Clip Imported into a Mobile Device](#)
- [Playing a Clip using the Player Screen](#)
- [Transferring a Clip to an FTP Server using the Player Screen](#)
- [Transferring Part of a Clip to an FTP Server](#)
- [Checking Clip Properties](#)
- [Checking the Job List](#)



## Transferring a Clip to an FTP Server using the Player Screen

You can transfer a clip from a camera to an FTP server using the player screen.

- 1 Configure FTP transfer settings on the camera beforehand.**
  - For details about FTP transfer settings on a camera, see the Help Guide or operating instructions for the camera.
- 2 Tap  (Menu) – [Browse].**
- 3 Select the type of clip.**

Tap the [Proxy] tab for proxy clips. Tap the [Original] tab for original clips.
- 4 If [Slot A] and [Slot B] are displayed, select the slot and then tap a clip.**

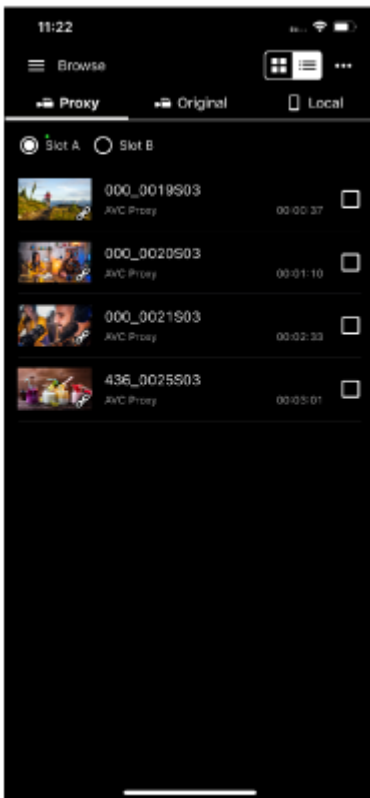

The player screen for the tapped clip appears.

- 5 Tap  (Transfer).**





The FTP transfer setup screen appears.

**6 Configure [Destination] and other transfer settings, then tap [OK].**

The proxy clip is transferred to the FTP server.

- You can check the FTP server transfer result and status in the job list. For details about the job list, see “Checking the Job List.”

**Hint**

- You can also specify and transfer a part of a clip to an FTP server. See “Transferring Part of a Clip to an FTP Server.”
- You can also transfer a clip from a camera to an FTP server using the [Browse] screen. See “Transferring a Clip to an FTP Server using the [Browse] Screen.”

**Related Topic**

- [Transferring Part of a Clip to an FTP Server](#)
- [Transferring a Clip to an FTP Server using the \[Browse\] Screen](#)
- [Checking the Job List](#)

TP1001125892

## Transferring Part of a Clip to an FTP Server

You can specify and transfer part of a clip from a camera to an FTP server using the player screen.

- 1 **Configure FTP transfer settings on the camera beforehand.**
  - For details about FTP transfer settings on a camera, see the Help Guide or operating instructions for the camera.
- 2 **Tap  (Menu) – [Browse].**
- 3 **Tap the [Original] tab.**
- 4 **If [Slot A] and [Slot B] are displayed, select the slot and then tap a clip.**

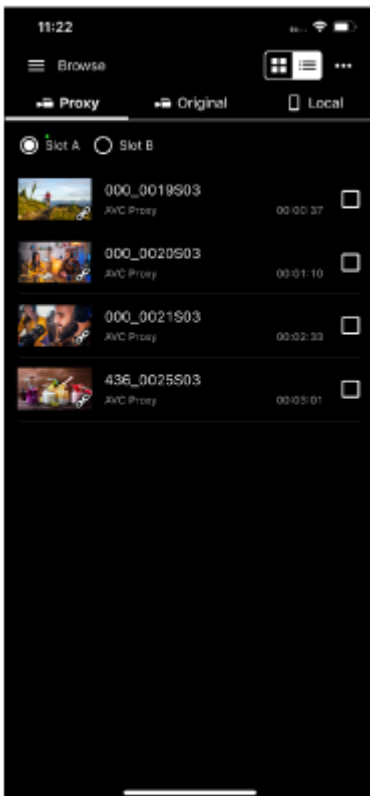



The player screen for the tapped clip appears.

- 5 **Play the clip, tap  (In) at the start position of the clip, and tap  (Out) at the end position.**

The region between  (In) and  (Out) becomes the clip to transfer.

### Note

- This function is not available if  (In) and  (Out) are not displayed on the screen.
- Information about the specified range is not saved in the clip.

**6** Tap  (Transfer).

The FTP transfer setup screen appears.

**7** Configure [Destination], [Clip name] (clip name generated for partial FTP transfer), and other transfer settings, then tap [OK].

The specified range proxy clip is transferred to the FTP server.

- You can check the FTP server transfer result and status in the job list. For details about the job list, see “Checking the Job List.”

**Hint**

- Tap an item displayed on the [In/Out] tab to jump to that range.

---

**Related Topic**

- [Playing a Clip using the Player Screen](#)
- [Checking the Job List](#)

TP1001125893

## Checking Clip Properties

You can check the properties of a clip.

- 1 Tap  (Menu) – [Browse].
- 2 Select the type of clip.  
Tap the [Proxy] tab for proxy clips. Tap the [Original] tab for original clips.
- 3 If [Slot A] and [Slot B] are displayed, select the slot and then tap a clip.

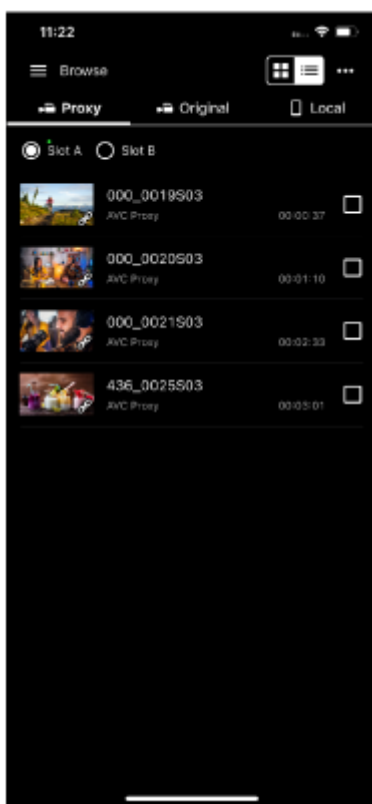

The player screen for the tapped clip appears.

- 4 Tap the [Property] tab.

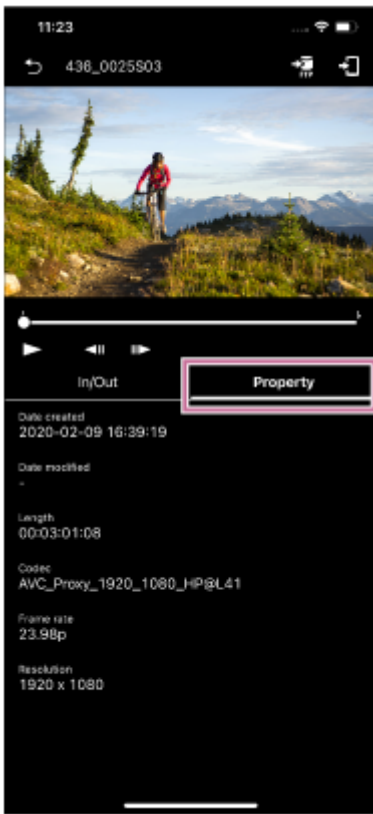

A list of metadata appears.

## Related Topic

- [Checking a Proxy Clip/Original Clip](#)

TP1001125894

H-479-100-12(1) Copyright 2023 Sony Corporation

## Checking the Job List

---



You can check the following information using the [Job list] screen.

### FTP transfer job list

Use to check the status when transferring clips to an FTP server. You can also control the FTP transfer (stop, resume, delete, refresh).

### Import job list

Use to check the status when importing proxy clips to a mobile device. You can also control the import (stop, resume, delete, refresh).

- 1 Tap  (Menu) – [Job list].
- 2 To check the FTP transfer job list, tap  (Transfer). To check the import job list, tap  (Import).  
The job list appears.
- 3 Place a check mark in the checkbox of the job to check.
- 4 Perform the following, as required.  
Stop job: Tap [Abort].  
Resume job: Tap [Continue].  
Delete job: Tap [Delete].  
Refresh job: Tap [Refresh].

---

### Related Topic

- [Importing a Proxy Clip using the Player Screen](#)
- [Transferring a Clip to an FTP Server using the Player Screen](#)
- [Transferring Part of a Clip to an FTP Server](#)

TP1001125895

## Trademarks

---

- Wi-Fi and Wi-Fi Direct are registered trademarks of Wi-Fi Alliance.
- QR Code is a trademark of Denso Wave Inc.
- IOS is a trademark or registered trademark of Cisco in the U.S. and other countries and is used under license.
- iPadOS and iPad Pro are trademarks of Apple Inc., registered in the U.S. and other countries and regions.
- Xperia is a trademark of Sony Mobile Communications AB.
- Android is a trademark of Google Inc.
- All other company names and product names are registered trademarks or trademarks of their respective owners. Trademarked items are not indicated by ™ or ® symbols in this document.

TP1001125896